

Touch Control



INSTALLATION INSTRUCTIONS (English)

Air for Life

BRINK

Air for life

WWW.BRINKAIRFORLIFE.NL

617055-C

Table of Contents

1	About this document.....	04
1.1	Scope of application of document.....	04
1.2	Target group.....	04
1.3	Other applicable documents.....	04
1.4	Safekeeping of these documents.....	04
1.5	Symbols.....	05
1.6	Warnings.....	05
2	Safety.....	07
2.1	Intended use.....	07
2.2	Incorrect use.....	07
2.3	Safety measures.....	08
3	Installation and electrical connection.....	09
3.1	Installation recommendations.....	09
3.2	Installing the wall bracket.....	09
3.3	Electrical connection.....	10
3.4	Decommissioning and maintenance.....	11
3.4.1	Decommissioning.....	11
3.4.2	Maintenance and cleaning.....	11
3.5	Recycling and disposal.....	11
4	Overview and symbols.....	12
4.1	Symbols in the display.....	12
5	Commissioning.....	14
6	General functions.....	15
6.1	Assignment of functions.....	15
6.2	Reset.....	16
6.3	Key lock.....	16
6.4	Energy saving mode and proximity sensor.....	17
6.4.1	Touch Control energy saving mode.....	17
6.5	Current time.....	17
6.6	Fault message / filter warning.....	18
6.6.1	Fault message page.....	18
6.6.2	Filter warning – ventilation unit.....	19

Table of Contents

7	Ventilation control unit functions	20
7.1	Ventilation level	20
7.2	Program selection - ventilation	20
7.3	Menu	21
7.3.1	Parameter list	21
7.3.2	Parameter list	21
7.3.3	Time program	22
7.4	Holiday mode	23
7.5	Party mode or boost mode	23
8	Appendix	24
8.1	Commissioning the Touch Control	24
8.2	Adjusting the ventilation level	26
8.3	Program selection	27
8.4	Holiday mode	28
8.5	Menu	29
8.6	Time programs	30
8.6.1	Day program	30
8.6.2	Week program	31
8.7	Specifications	32
9	EU DECLARATION OF CONFORMITY	33
10	Notes	34

1 About this document

- ▶ Read this document before you begin working on the appliance.
- ▶ Follow the instructions in this document.

Failure to observe these instructions voids any warranty provided by the manufacturer Brink.

1.1 Scope of application of document

This document contains instructions for the factory-assembled and type-approved Touch Control.

1.2 Target group

This document is intended for technicians and the system users.

1.3 Other applicable documents

The documents for all accessory modules and other accessories also apply where relevant.

1.4 Safekeeping of these documents



Documents must be kept in a suitable location and must be available at all times.

The user is responsible for the safekeeping of all documents.

The documents are provided by the contractor.

1.5 Symbols

The following symbols are used in this document:

Symbol	Meaning
▶	An action which must be taken
	A necessary requirement
	The outcome of an action
	Important information regarding the proper use of the appliance
	A reference to other relevant documents

* Table footnotes

Table 1.1 Meaning of the symbols

1.6 Warnings

Warnings in the text warn you of possible risks before the start of an instruction. The warnings provide you with information on the possible severity of the risk using a pictogram and a keyword.





Symbol	Keyword	Explanation
	DANGER	This means that there is a risk of serious injury or loss of life.
	WARNING	This means that there is a potential risk of serious injury or loss of life.
	CAUTION	This means that there is a potential risk of minor to moderate injury.
	NOTE	This means that material damage may occur.

Table 1.2 Meaning of warnings

About this document

Layout of warnings

These warnings are laid out as follows:



KEYWORD

Type and source of risk!

Explanation of the risk.

▶ Action to prevent the risk.

2 Safety

Work must be performed by a contractor.

- ▶ Only qualified electricians are permitted to work on electrical components in accordance with VDE.

2.1 Intended use

The Touch Control is used exclusively in connection with Brink heat recovery devices and Brink accessories.

The Touch Control is used to control a ventilation system and to set specific parameters.

Intended use also includes observing the operating instructions and all other applicable documents.



The touch fields will not work properly if your hands are wet or if you are wearing gloves.

2.2 Incorrect use

The appliance may be used by children aged 8 and older, by persons with impaired mental capacities, physical disabilities or insufficient knowledge and experience only if they are supervised or have received corresponding instructions on how to safely use the device and provided they are aware of the possible dangers. Children under 3 years must be kept away from the appliance unless they are constantly supervised. Children aged 3 to 8 may only switch the appliance on and off if they are supervised while doing so or have been clearly trained in the use of the device and have understood the resulting dangers, assuming that the appliance has been set up and installed in the normal operating position. Children aged 3 to 8 may not insert the plug into the socket or switch on the appliance; they also may not clean the appliance or perform any maintenance work that is normally performed by the user. Children must not play with the appliance.

2.3 Safety measures

Never remove, bypass or otherwise disable any safety or monitoring equipment. Only operate the system if it is in perfect technical condition. Any faults or damage that impact or might impact safety must be remedied immediately by a qualified contractor.

- ▶ Replace faulty parts with original Brink replacement parts.

3 Installation and electrical connection

The Touch Control must be fixed to the wall using the wall bracket. It can be placed directly on the wall or on a flush-mounting box.

3.1 Installation recommendations

- Install the Touch Control on an internal wall approximately 1.5 m above the floor.
- Keep the Touch Control out of direct sunlight and UV radiation.

3.2 Installing the wall bracket

The wall bracket is fitted to the wall or the flush-mounting box using the two included screws and dowels (hand-tight with a screwdriver).



Feed the cable through the entry point before installing the wall bracket.

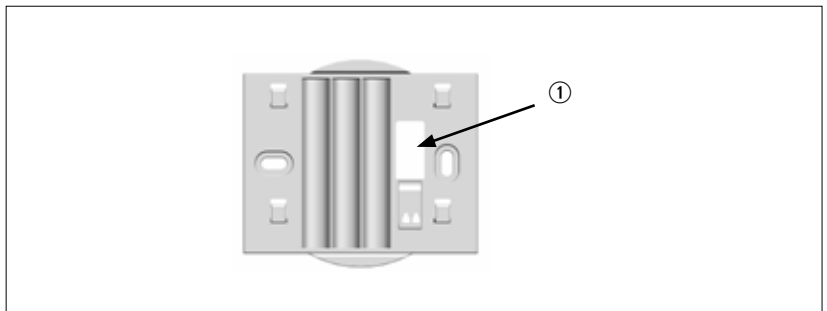

Fig. 3.1 Wall bracket

① Cable entry (eBus)

3.3 Electrical connection

Touch Control

In order for the Touch Control to be connected to the power, the eBus cable (2-pin) must be connected to the terminals of the wall mounted base. The polarity (+/-) must not be observed. Cable diameter: 0.5...0.8 mm².

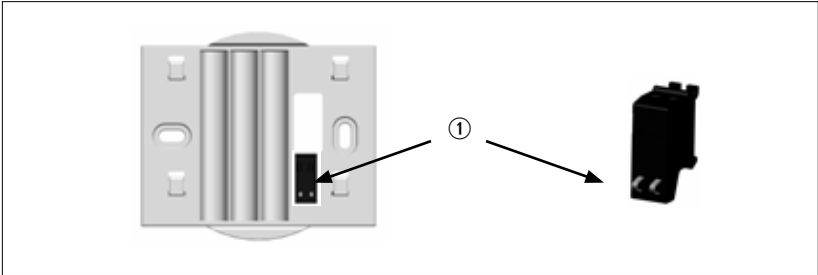

Fig. 3.2 Touch Control terminals (eBus)

① eBus terminals (protected against polarity reversal)

► Push the terminals with a screwdriver to insert the cable
Once the electricity has been connected, the Touch Control can be placed on the four fixing hooks of the wall bracket (“put in place and pushed downwards”).

3.4 Decommissioning and maintenance

3.4.1 Decommissioning

To decommission the Touch Control unit, follow the installation sequence in reverse order.

3.4.2 Maintenance and cleaning

The Touch Control is maintenance-free. Do not use a cleaning agent. Only wipe with a damp cloth.

3.5 Recycling and disposal



Do not dispose of as household waste!

- ▶ In accordance with the Waste Disposal Act, the following components must be disposed of or recycled in an environmentally compatible manner by means of appropriate collection points:
 - Old appliance
 - Wearing parts
 - Defective components
 - Electrical or electronic waste
 - Environmentally hazardous liquids and oilsEnvironmentally compatible means separated by material groups to ensure the greatest possible recyclability of the base materials with the minimum environmental impact.
- ▶ Dispose of packaging made of cardboard, recyclable plastics and synthetic filler materials in an environmentally compatible manner through appropriate recycling systems or a recycling centre.
- ▶ Please observe the applicable national and local regulations.











4 Overview and symbols











Fig. 4.1 Touchpanel overview

4.1 Symbols in the display

The symbols displayed depend on the operating state.

Symbol	Explanation
	eBus connection
	Program selection: Automatic mode
	Program selection: Standby
	Holiday mode (touch key):
	Fault or filter warning
	Program selection: Manual mode (ventilation)
	Cancel (touch key)
	Confirm (touch key)
	Parameter list menu (touch key)
	Program selection (touch key)

Overview and symbols

Symbol	Explanation
	Time program menu (touch key)
	Change status page or display/parameter values (touch keys)
	Decrease value/setpoint (touch key)
	Increase value/setpoint (touch key)
	Menu (touch key)
ON OFF	Indicates whether the temperature is set to increase (ON) or decrease or the unit switches to standby (OFF) at a specific time
	Clear switching time of the time program (touch key)
	Ventilation levels 0 to 3 Note: "4" means automatic operation, e.g. based on an overriding CO ₂ sensor!
	Program selection: Boost mode (ventilation; FW4.10+)

5 Commissioning

After the electrical connection and installation of the Touch Control, it starts automatically and begins with the system recording.

If a compatible ventilation device is detected, the standard display appears automatically.

Note:

If the Touch Control is to be used for another ventilation device at a later point in time, a reset must first be carried out! [“Reset” on page 16](#)

6 General functions



6.1 Assignment of functions

Functions	
Adjusting the ventilation level	x
Information about the status of the heating appliance	x
Configure parameter values	x
Fault display	x
Filter warning – ventilation unit	x
Daily or weekly time program for ventilation	x
Setting and displaying the time	x
Holiday mode	x
Manual mode / automatic mode	x



Information about configuration options and operation is provided in the flowcharts in the Appendix (see Section 8)

6.2 Reset

- ▶ Hold down the  /  keys for at least 5 seconds. This will work even if the keys are not visible, but will not work if the button lock is active.
- “rES” will be shown on the display for five seconds
- Touch Control will then restart and reinitialise itself



All settings in the Touch Control are lost

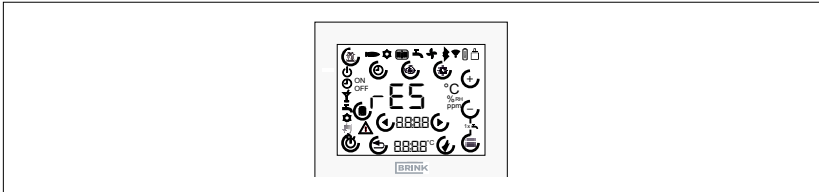





Fig. 6.1 Reset

6.3 Key lock

The display can be locked by pressing the  /  keys at the same time for at least five seconds. This will make it impossible to make any changes.

The program selection, holiday mode and menu symbols are hidden. To unlock the display, either hold down the two  /  keys for at least five seconds or restart the Touch Control.

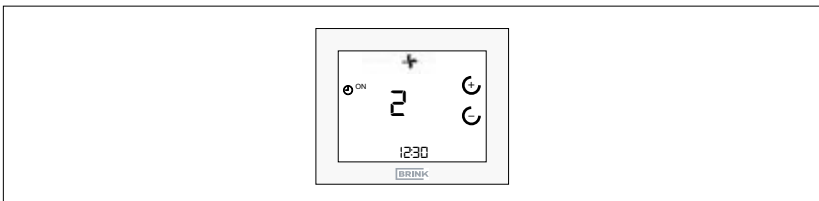

Fig. 6.2 Remove key lock

6.4 Energy saving mode and proximity sensor

6.4.1 Touch Control energy saving mode

The Touch Control will switch to energy saving mode if it has not been used in 5 minutes. The backlighting will be dimmed, and the display will only show the current air level along with the time.

To exit energy saving mode

- ▶ The Touch Control will detect anyone within approx. 5 cm.

6.5 Current time



In the standard display of the Touch Control, the set time is shown in the bottom 7-segment display.

6.6 Fault message / filter warning

6.6.1 Fault message page

- For fault codes, see the installation instructions of the connected appliance.

If the Touch Control detects a fault in the eBus system, a separate fault message page will be displayed showing the fault code.

Press the / keys to return to the standard view.



The fault symbol is shown on the standard view, in addition to the arrow keys used for navigation.

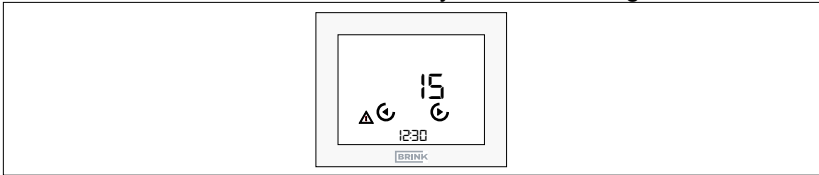

Fig. 6.3 Fault display





Fault messages cannot be acknowledged using the Touch Control!

6.6.2 Filter warning – ventilation unit

- ▶ Reset the filter warning after replacing or cleaning the filter(s).

If a filter warning occurs, a separate warning symbol is displayed. This page will include the letters “FIL” and a blinking fault/warning symbol.

- ▶ To acknowledge the filter warning, press the  key
- ▶ Press the /  keys to switch to the standard view



The fault/warning symbol will also flash on the standard view

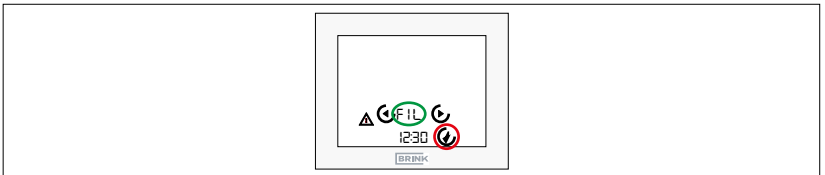









Fig. 6.4 Reset filter warning





7 Ventilation control unit functions

7.1 Ventilation level

- ▶  Press these keys in the standard ventilation display
- ▶ Ventilation level flashes
- ▶ The value can be changed with the  keys
- ▶ Press the  key to confirm
- ▶ Press the  key to cancel, or wait for one minute without Operating the Touch Control.

7.2 Program selection - ventilation

- ▶  Press this key in the standard ventilation display
- ▶ Select the desired program with  keys
- ▶ Press  to confirm
- ▶ Press  to cancel, or wait for one minute without using the Touch Control.

Symbol	Function
	Automatic mode: Switch between reduced ventilation and nominal ventilation
	Example 1 (during time program): Nominal ventilation Example 2 (not during time program): Reduced ventilation
	Manual mode: Ventilation level remains in effect until it is changed manually
	Party mode or boost mode: Intense ventilation (level 3) can be activated for a configurable time. After the time has elapsed, the previously selected program becomes active again. (Available from FW4.10)
	In automatic mode, manual changes to the ventilation level only apply until the next switching time!

7.3 Menu









- ▶  Press this key in the standard display

7.3.1 Parameter list

Excerpt from the RM-2 instructions, see here:

Index	Meaning	Setting range	Factory setting
P 01	Time	00:00 – 23:59	00:00
P 02	Day of week	1 – 7 (Monday – Sunday)	1
P 03	Time program type	0 – 1 (0 = day program 1 = week program)	0
P 46	Bypass temperature (as with ventilation unit)	15°C – 35°C	24°C
P 64	Display brightness	0 ... 3	3

7.3.2 Parameter list

- ▶ Press the  key for the parameter list
- ▶ Use the  /  keys to navigate through the parameter list
- ▶ Select a parameter by pressing the  /  keys to enter editing mode.
- ▶ The value can be changed with the  /  keys
- ▶ Press  to confirm
- ▶ Press  to cancel, or wait for one minute without using the Touch Control.

7.3.3 Time program

► Press the  key

- All other settings are shown in the images in Section 8.3 of the Appendix.
- General info about time programs.

Separate day or week programs (depending on parameter P 03) exist for ventilation:







- The program switches between the ventilation levels nominal ventilation - level 2 (ON) and reduced ventilation - level 1 (OFF).

Up to three switching blocks (3 “ON” switching times and 3 “OFF” switching times) can be configured per day for each program:

Switching time Factory setting	Status	Time Ventilation
1	Start (ON)	6:00
1	End (OFF)	22:00
Switching time Setting	Status	Time Ventilation
1	Start (ON)	
1	End (OFF)	
2	Start (ON)	
2	End (OFF)	
3	Start (ON)	
3	End (OFF)	

Table 7.1 Switching times

7.4 Holiday mode

- ▶  Press this key in the standard display.
- ▶ Set the duration using the  /  keys (15 minutes – 99 days)
- ▶ Press  to enter and confirm
- ▶ Press  to cancel. The RM-2 will also return to the menu automatically if not used for one minute (RM-2 Wireless: 30 seconds).
- ▶ Exit holiday mode
 - Ends automatically after the time period
 - Manual deactivation:
- ▶ Press the holiday key, “OFF” will appear in the display
- ▶ Press  to confirm

Symbol	Function
--------	----------



	Holiday mode: Moisture protection mode for a predefined period (15 min. to 99 days)
--	---

7.5 Party mode or boost mode

- ▶  Press this key in the program selection.
- For information on activating the function, see Section 7.2

Symbol	Function
--------	----------





	Boost mode: Intense ventilation (level 3) can be activated for a configurable time. After the time has elapsed, the previously selected program or ventilation level becomes active again. (Available from FW4.10)
--	--

8 Appendix

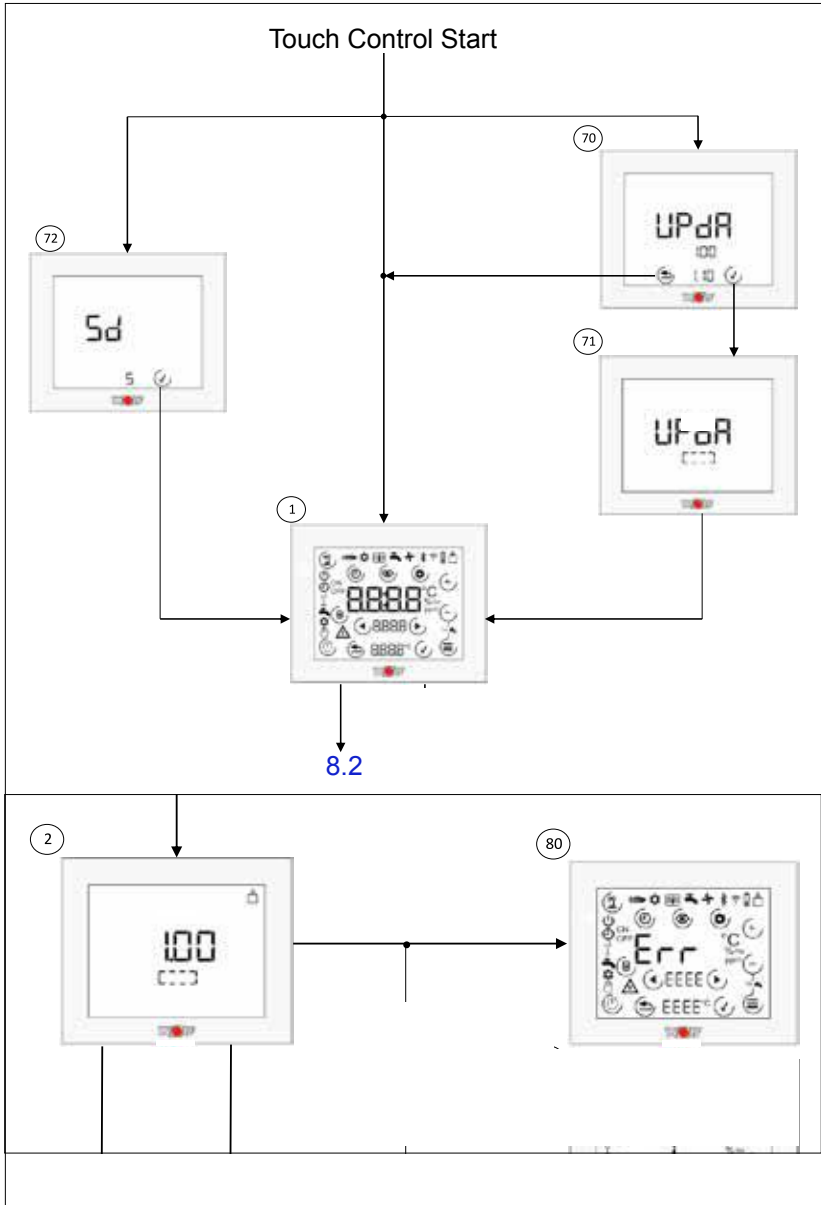
8.1 Commissioning the Touch Control



- ① **Startup screen.** Displayed if you turn on the Touch Control with no SD card installed or if there is no Touch Control firmware (FW) on the SD card. All symbols will be displayed for 2 seconds
- ⑦⑩ **Update Touch Control.** Appears when SD card is inserted and FW SD card > FW Touch Control. The current FW version will be displayed on the top. The new FW version will be displayed on the bottom. Press the  key to apply the update or the  key to skip it.
- ⑦① **Perform update.** A moving rectangle will be displayed while the update is underway.
- ⑦② **Forget SD card.** If the unit detects that the version of the FW on the SD card is earlier than the FW of the Touch Control after a restart, "Sd" will be displayed for 5 seconds. Use the  key to skip this screen.
- ② **Initialising the ventilation system.** The Touch Control will establish the eBus connection and look for Brink components in the system. A moving rectangle will be displayed along with the current FW version while it is searching.
- ⑧⑩ **Fault message page.** Appears if no compatible Brink system is detected when the unit is turned on for the first time. It will also appear if the connected ventilation unit was not detected when using the unit as a controller.

8.2 Adjusting the ventilation level

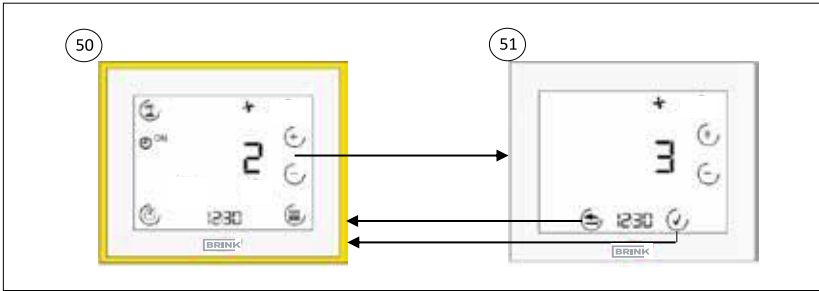

- ⑤⑩ **Standard ventilation display.** This display includes the current ventilation level (number + symbol) and the program selection for the ventilation unit. A number of different sub-menus are available.
- ⑤⑪ **Adjusting the ventilation level.** Use the \oplus/\ominus keys to adjust the ventilation level. The value will flash. Use the \checkmark key to apply the change or the \leftarrow key to discard the change.

8.3 Program selection

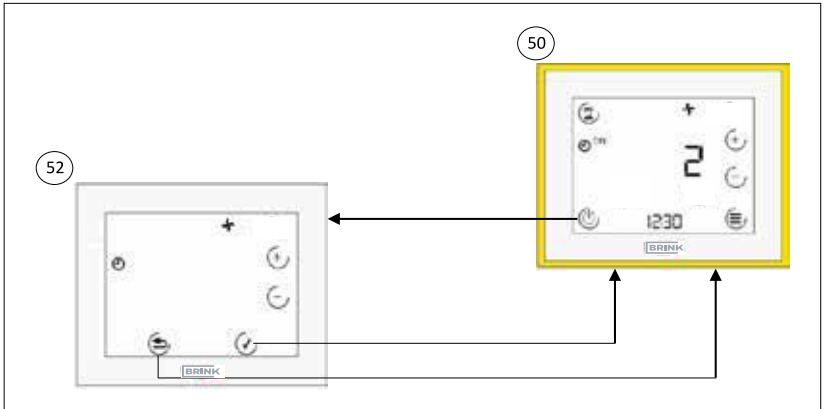

- ⑤⑩ **Standard ventilation display.** This display includes the current ventilation level (number + symbol) and the program selection for the ventilation unit. A number of different sub-menus are available.
- ⑤② **Program selection - ventilation.** The \oplus/\ominus key can be used to switch between the automatic mode and manual mode (value flashes). Confirm the program with the \checkmark key and discard it with the \curvearrowright key.

8.4 Holiday mode

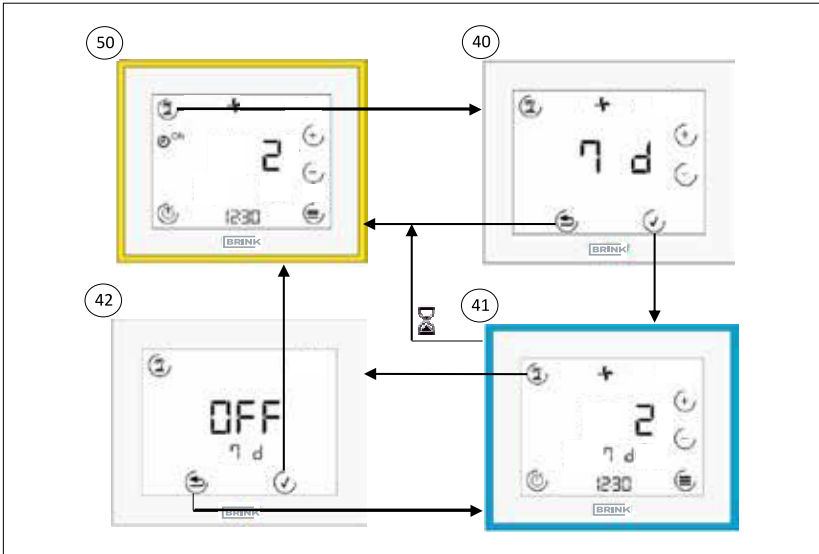

- ⑤① **Standard ventilation display.** This display includes the current ventilation level (number + symbol) and the program selection for the ventilation unit. A number of different sub-menus are available.
- ④① **Holiday mode duration.** When you press the Holiday key, you need to set the duration of Holiday mode. You can do this using the \oplus/\ominus key. Use the \checkmark key to confirm or the \otimes key to cancel.
- ④① **Holiday mode active.** Same options as in the standard view. The remaining time is displayed under the room temperature. The Holiday symbol flashes when active. You can exit Holiday mode by pressing the Holiday button again. The unit will exit Holiday mode automatically after the specified time has passed.
- ④② **Exit Holiday mode.** You can exit Holiday mode by pressing the \checkmark key again (OFF).

8.5 Menu

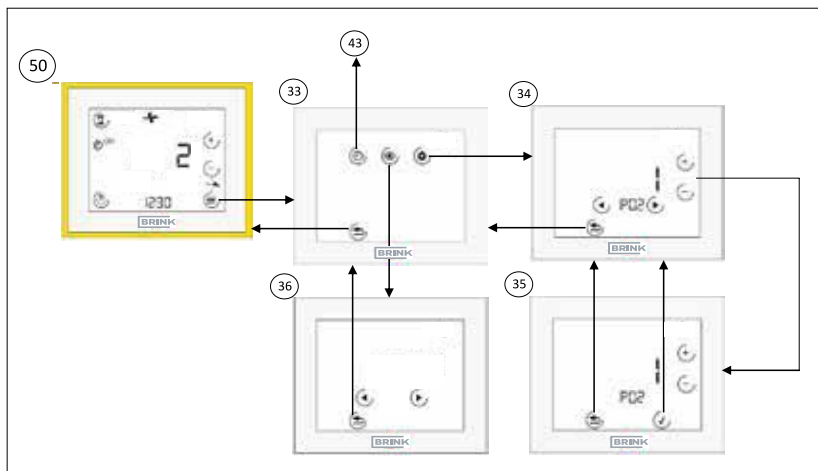

- ⑤⑩ **Standard ventilation display.** This display includes the current ventilation level (number + symbol) and the program selection for the ventilation unit. A number of different sub-menus are available. See item 44 (Section 8.6.1) or item 48 (Section 8.6.2)
- ③③ **Menu.** You can choose between parameter values and configure time programs in this menu. See item 44 (Section 8.6.1) or item 48 (Section 8.6.2)
- ③④ **Parameter values.** Use the arrow keys to switch between parameters. Use the \oplus/\ominus key to switch to edit mode.
- ③⑤ **Parameter edit mode.** Use the \oplus/\ominus keys to change the parameter. The value will flash. Use the \hookrightarrow -key to apply the change or the \curvearrowright key to discard the change.

8.6 Time programs

8.6.1 Day program

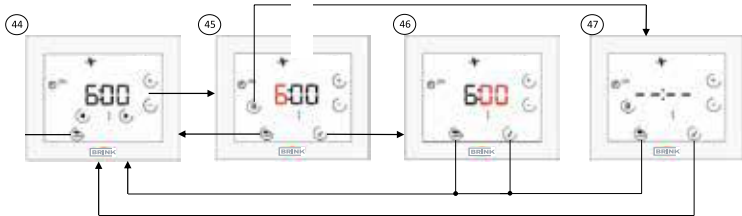

- ④④ **Set time program for one day.** Use the arrow keys to switch between switching times (1, ON; 1, OFF;...3, OFF). The currently selected switching time will flash. Use the + or - key to switch to edit mode for the hour. Use the waste bin symbol to delete the switching time (ON + OFF!).
- ④⑤ **Hour edit mode.** Use the \oplus/\ominus key to set the hour. The value will flash. Use the \checkmark key to apply the change or the \ominus key to discard the change.
- ④⑥ **Minutes edit mode.** Use the \oplus/\ominus key to set the minutes. The value will flash. Use the \checkmark key to apply the change or the \ominus key to discard the change.
- ④⑦ **Delete switching time.** Use the \checkmark key to delete the displayed block or the \ominus key to keep it.

8.6.2 Week program

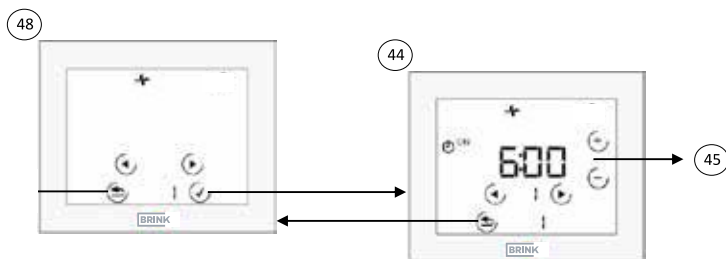

- ④⑧ **Weekday selection menu** (only available if P03 = 1). Use the arrow keys to select the weekday. The value will flash. The following applies: 1 = Monday...7 = Sunday. The next step is the same as for the day program. The only difference is that the weekday will be displayed on the bottom row
- ④④ **Set time program for one day.** Use the arrow keys to switch between switching times (1, ON; 1, OFF;...3, OFF). The currently selected switching time will flash. Use the + or - key to switch to edit mode for the hour. Use the waste bin symbol to delete the switching time (ON + OFF!).

8.7 Specifications

Description	
IP rating	IP20
Protection class	III
Operating voltage	9-24 V (eBus)
Ambient temperature in operation	0...60 C°
Storage temperature	-30...70 C°
Humidity during operation (non-condensing)	20...90% rel.
Max. current drawn	40 mA
Time switch power backup	48 h
Communication and power supply via 2-core cable	0.5...0.8 mm ²
Contamination level	2
Temperature for the ball pressure test	75°C

9 EU DECLARATION OF CONFORMITY

(to ISO/IEC 17050-1)

Issued by: **Brink Climate Systems B.V.**
Address: PO box 11
NL-7950 AA Staphorst, Netherlands

Product: Touch Control

The product described above conforms to the requirements specified in the following documents:

Touch Control:

EN 60730-1:2016
EN 60730-2-11:2008
EN 60950-1:2006+A11:2009+A1:2010+A12:2011+A2:2013+AC:2011
EN 301489-1 V2.2.0
EN 301489-3 V2.1.1
EN 301489-17 V3.2.0
EN 300328 V2.1.1

In accordance with the following Directives:

2014/35/EU (Low Voltage Directive)
2011/65/EU (RoHS2 Directive)
2014/30/EU (EMC Directive)

this product is identified as follows:



This declaration of conformity is issued under the sole responsibility of the manufacturer.
Staphorst, 14/06/2021

A handwritten signature in black ink, appearing to be 'A. Hans', written in a cursive style.

*A. Hans,
Director*

10 Notes

WWW.BRINKAIRFORLIFE.NL

BRINK

Air for life

BRINK CLIMATE SYSTEMS B.V.

Wethouder Wassebaliestraat 8 7951 SN Staphorst Netherlands
PO box 11 NL-7950 AA Staphorst Netherlands
T. +31 (0) 522 46 99 44
F. +31 (0) 522 46 94 00
info@brinkclimatesystems.nl
www.brinkclimatesystems.nl

617055-C