

# INSTALLATION REGULATIONS

## Ubiflux Vigor W600



English



La puissance pure!



# Installation regulations

Heat recovery appliance:

Ubiflux Vigor W600



Store near the appliance

This appliance may be used by children as of 8 years of age, persons with reduced physical or mental capacities, and persons with limited knowledge and experience if they are supervised or have received instructions on how to use the appliance safely and are aware of the possible dangers. Children younger than 3 years of age must be kept away from the appliance, unless they are under constant supervision. Children between the ages of 3 and 8 may only switch the appliance on or off, but only if supervised or if they have received clear instructions on the safe use of the appliance and understand the possible dangers, on the condition that the appliance has been placed and installed in the normal position for use. Children between the ages of 3 and 8 may not insert the plug into the socket, nor clean or make changes to the settings of the appliance, nor carry out any maintenance on the appliance that would normally be carried out by the user. Children may not play with the appliance. **If you need a new power cable, always order the replacement from Ubbink NV. To prevent dangerous situations, a damaged mains connection must only be replaced by a qualified expert!**

Country: GB

# Contents

<b>1 Delivery</b>	<b>5</b>		
1.1 Delivery size.	5	9.2 Maintenance siphon	30
		9.3 Maintenance installer	31
<b>2 General</b>	<b>6</b>	<b>10 Electrical diagram</b>	<b>34</b>
<b>3 Modèle</b>	<b>7</b>	<b>11 Electrical connections accessories</b>	<b>36</b>
3.1 Technical information Ubiflux Vigor 600	7	11.1 Connecting multiple switch	36
3.2 Connections and dimensions	8	11.1.1 Connecting multiple switch with filter indication	37
3.3 Exploded view of appliance	10	11.1.2 Connecting wireless remote control (without filter indication)	38
		11.1.3 Connecting extra multiple switch with filter indication	39
		11.1.4 Connecting extra multiple switch with filter indication	40
		11.2 Connecting Air Control	41
		11.3 Connecting humidity sensor	42
		11.4 Connecting CO <sub>2</sub> sensor(s)	43
		11.5 Connecting postheater	44
		11.6 Connecting preheater	44
		11.7 Connecting Geo-heat exchanger	45
<b>4 Operation</b>	<b>11</b>	<b>12 Service</b>	<b>47</b>
4.1 Description	11	12.1 Exploded view	47
4.2 Bypass	11	12.2 Service articles	48
4.3 Frost protection	12	<b>13 Setting values</b>	<b>50</b>
4.4 Optional Plus pcb	12	13.1 Setting values standard appliance	50
		13.2 Setting values appliance with Plus pcb	53
<b>5 Installation.</b>	<b>13</b>	<b>14 Conformity declaration</b>	<b>55</b>
5.1 Installation general	13	<b>15 ERP values Ubiflux Vigor W600</b>	<b>56</b>
5.2 Placing the appliance	13	<b>16 Recycling</b>	<b>58</b>
5.3 Connecting the condensate discharge	14		
5.4 Connecting air ducts	15		
5.5 Electrical connections	16		
5.5.1 Connecting the power plug	16		
5.5.2 Connecting the multiple switch	17		
5.5.3 Connecting an eBus accessory	17		
5.5.4 24 volt connection	17		
5.5.5 Connecting humidity sensor	17		
5.5.6 Connection internal Bus	17		
5.5.7 Connecting "signal output" connector « signal output »	17		
5.5.8 ModBus Connection	17		
5.5.9 Coupling appliances using internal Buss	18		
<b>6 Display</b>	<b>19</b>		
6.1 General explanation of control panel	19		
6.2 Display layout	20		
6.3 Display information	23		
<b>7 Starting appliance</b>	<b>24</b>		
7.1 Switching appliance on and off	24		
7.2 Setting the air flow	24		
7.3 Other settings for installer	25		
7.4 Factory settings	25		
<b>8 Fault</b>	<b>26</b>		
8.1 Fault analysis	26		
8.2 Display Codes	26		
<b>9 Maintenance</b>	<b>29</b>		
9.1 Cleaning filters	29		

# 1 Delivery

## 1.1 Delivery size

Before installation of the heat recovery appliance is started, check that it has been supplied in complete and undamaged condition.

The delivery size of the heat recovery appliance type Vigor W600 consists of the following components:

1. Heat recovery appliance
2. Wall mounting bracket consisting of:
  - 1x mounting bracket
  - 2x protective caps
  - 2x rubber strips
  - 3x rubber rings
  - 1x washer
3. Siphon
4. Documentation set consisting of:
  - 1x short installation instructions
  - 1x occupant's instructions

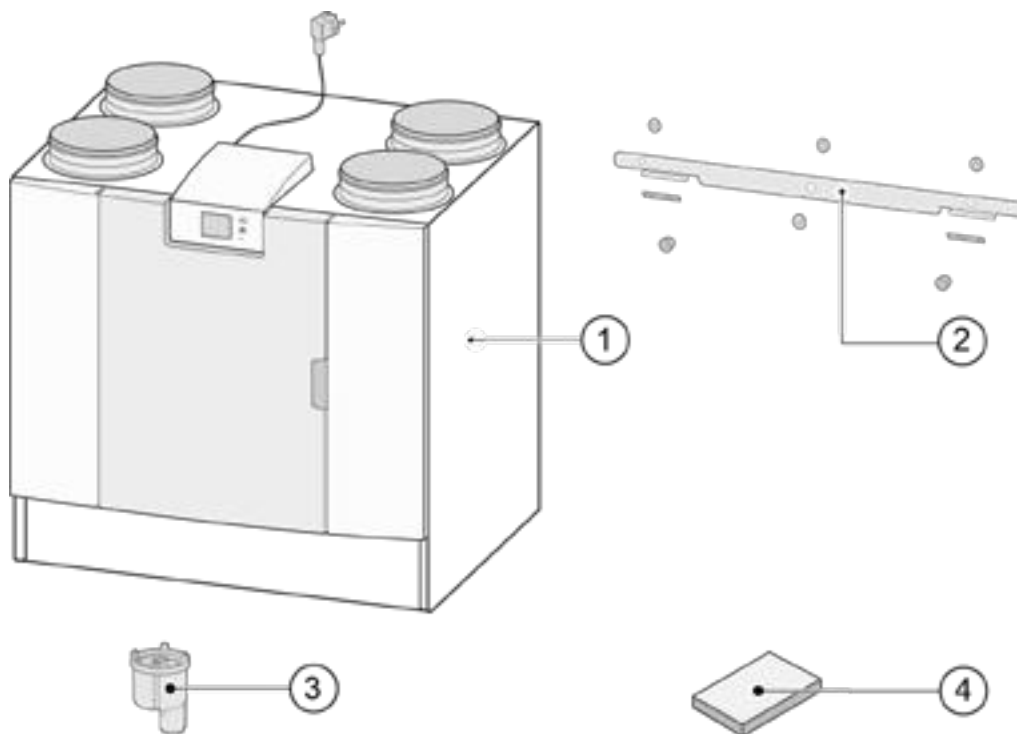

## 2 General

The Ubiflux Vigor W600 is a ventilation unit with heat recovery for the balanced ventilation of dwellings.

Features :

- Maximum capacity 450 m<sup>3</sup>/h or 600 m<sup>3</sup>/h
- High efficiency heat exchanger
- Filters ISO Coarse 60%
- Modular electric preheater
- Automatic bypass valve
- Touchscreen
- Adjustable air quantity
- Filter indication on the appliance and the possibility of a filter indication on the multiple switch
- An intelligent frost protection
- Low sound level
- Constant flow control

For the Ubiflux Vigor W600 there is an optional Plus PCB available with more functions/ connection possibilities (→ Electrical diagram page 34).

These installation instructions describe both the standard Ubiflux Vigor W600 and the Ubiflux Vigor W600 with optional Plus PCB.

The Ubiflux Vigor W600 is available in Left-hand and Right-hand versions; it is not possible to convert the **left** and **right-hand** models into one another. For the correct connection ducts and dimensions (→ Connections and dimensions page 15).

For continues balanced ventilation, we recommend, using an additional external preheater for environments with a outside temperature less then -15 °C. When the appliance is placed in an area where very cold outside air is expected for a long time (→ 25°C), an extra preheater (see \* Connecting preheater page 45 ) must always be installed!

The appliance comes ready to plug in with a 230 V mains plug.

# 3 Version

## 3.1 Technical information

Ubiflux Vigor W600										
Supply voltage [V/Hz]	230V/50Hz									
Dimensions (l x h x p) [mm]	850 x 800 x 660									
Duct diameter [mm]	ø200									
Ext. diameter condensate discharge [mm]	ø32									
Weight [kg]	53									
Filter class	ISO Coarse 60% (ISO ePM1.0 50% for the air supply optional)									
Fan setting (factory setting)	0		1		2		3		max	
Factory setting [m³/h]	100		150		300		500		600	
Permissible resistance of duct system [Pa]	3	6	6	13	25	50	69	139	100	188
Rated power (excl. preheater) [W]	12,1	12,5	17,2	18,3	44,5	54,2	166,6	203,1	260,6	288,0
Rated current (excl. preheater) [A]	0,18	0,19	0,23	0,24	0,46	0,55	1,45	1,71	2,11	2,3
Max. rated current (incl. preheater switched on) [A]	5.7									
Rated power preheater [W]	1000									
Cos φ	0,288	0,291	0,322	0,327	0,421	0,427	0,500	0,516	0,536	0,544
Sound power										
Ventilation capacity [m³/h]										
Sound power level Lw(A)	Static pressure [Pa]									
	Casing radiation [dB(A)]									
	Duct 'From dwelling' [dB(A)]									
	Duct 'To dwelling' [dB(A)]									

\*) Duct noise including end correction  
In practice the value may differ by 1dB(A) through measurement tolerances.

Resistance of ductsystem [Pa]

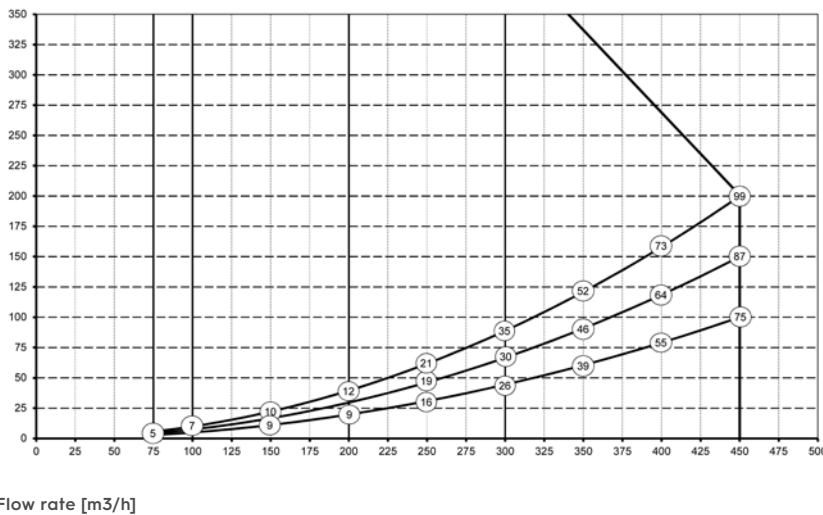

**Note:** The stated value in the circle is the capacity (in Watt) per fan.

## 3.2 Connections and dimensions

The Ubiflux Vigor is available in a left-hand and right-hand version. With a left-hand version the “warm” connections (from dwelling 3 and to dwelling 1) are on the left-hand side of the appliance; the condensate discharge is then mounted at the right-hand opening below the appliance. With a right-hand version the “warm” connections (1 & 3) are on the right-hand side of the appliance.

Left-hand version

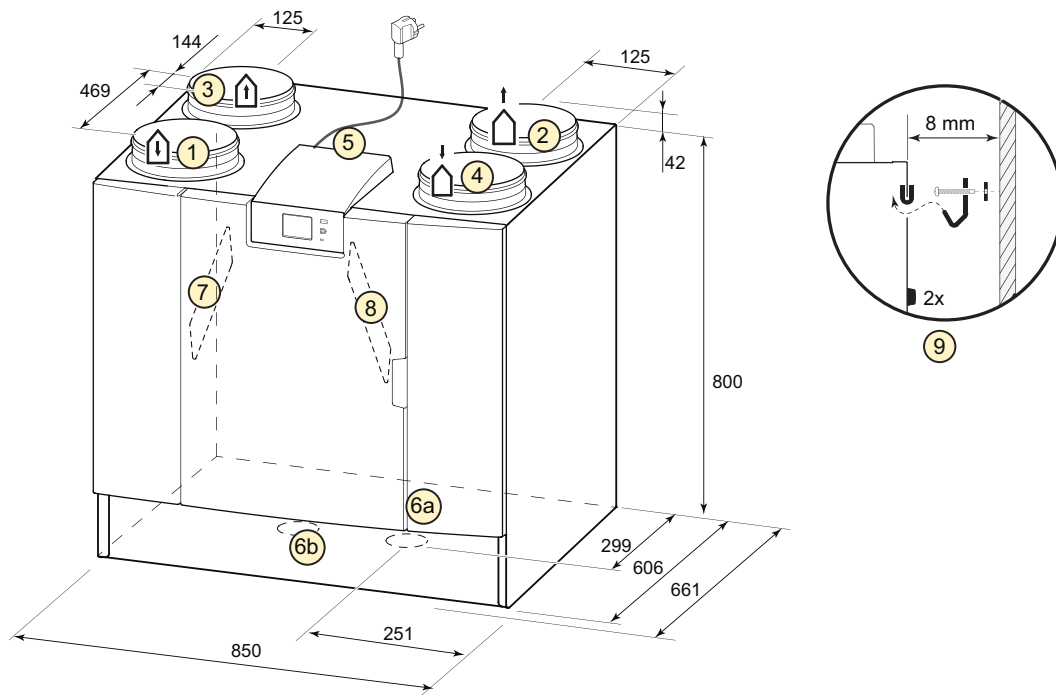



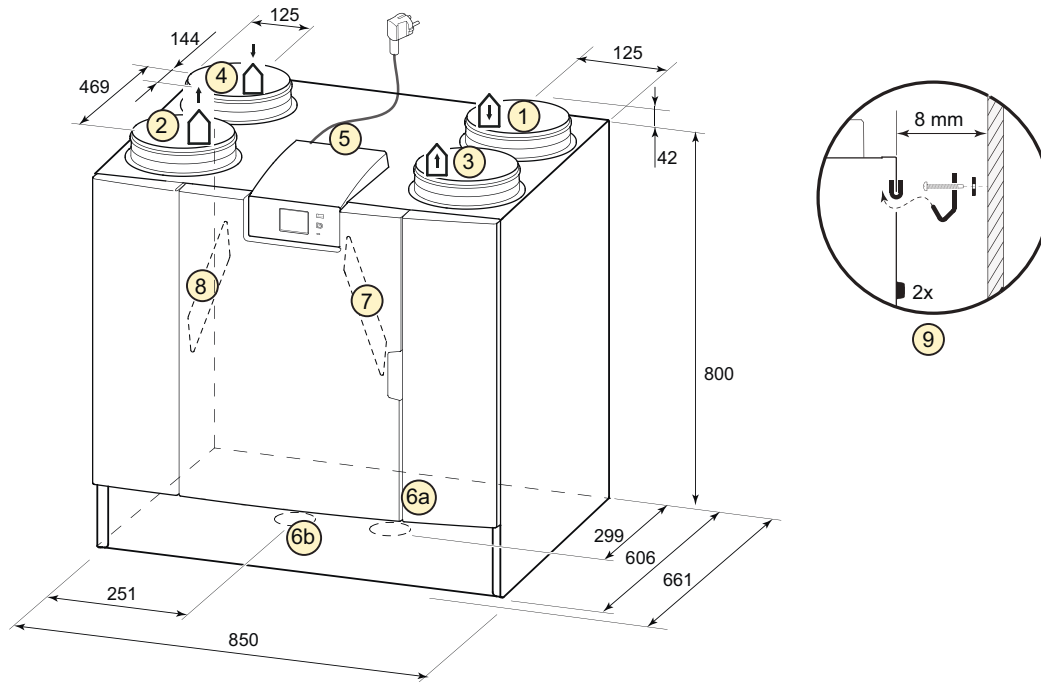

All dimensions in millimeters. Diameter of all collars is 200 mm

1	Supply air	
2	Exhaust air	
3	Extract air	
4	Outdoor air	
5	Electrical connections	
6a	Siphon connection	
6b	Sealing cap unused condensate discharge connection; do not remove!	
7	Extract air filter	
8	Supply air filter	
9	Mounting bracket	

Right-hand version



All dimensions in millimeters. Diameter of all collars is 200 mm

1	To dwelling	
2	Exhaust air	
3	Extract air	
4	Outdoor air	
5	Electrical connections	
6a	Siphon connection	
6b	Sealing cap unused condensate discharge connection; do not remove!	
7	Extract air filter	
8	Supply air filter	
9	Mounting bracket	

### 3.3 Exploded view of appliance

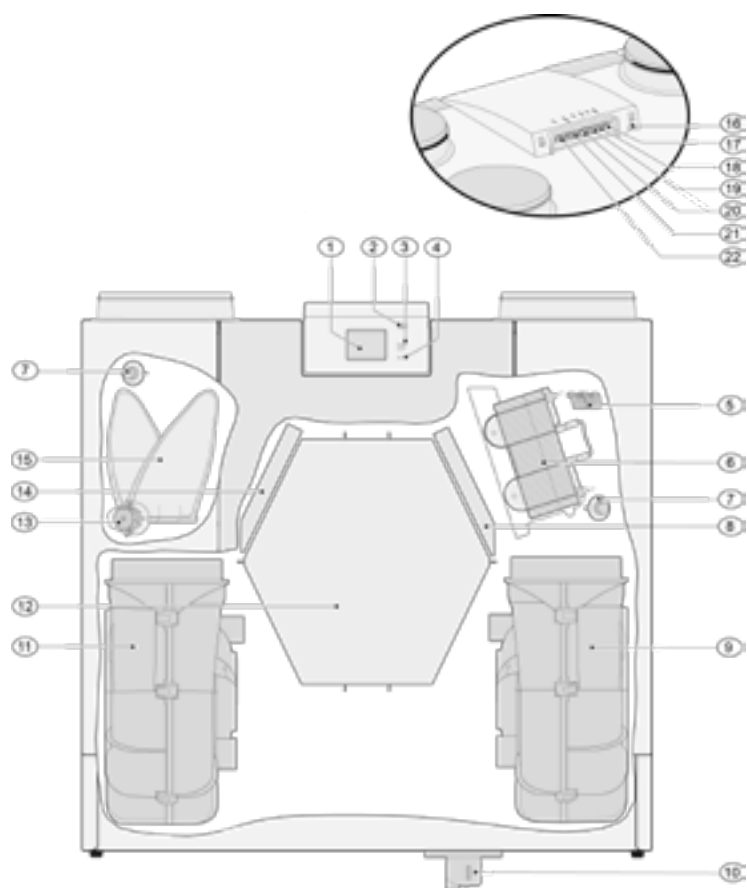

The appliance shown above is a left-hand version: in the case of a right-hand version, the connector of the preheater, bypass valve and the siphon connector are installed in mirror image!

1	Touchscreen	12	Heat exchanger
2	USB connector (X13)	13	Motor bypass valve
3	Service connector	14	Exhaust air filter
4	LED indicator	15	Bypass valve
5	Maximum protection preheater	16	Power cable 230 volt
6	Preheater	17	Signal output (X19)
7	Temperature sensor (2x)	18	24 volt connector (X18)
8	Supply filter	19	eBus connector (X17)
9	Exhaust fan	20	24 volt connector (X16)
10	Siphon	21	Modbus/ internal bus connector (X15)
11	Supply fan	22	Multiple switch connector (X14)

# 4 Operation

## 4.1 Description

The appliance is supplied ready for plugging in and works automatically according to the standard settings. The discharged dirty indoor air warms up the fresh clean outdoor air. That saves energy while fresh air is supplied to the desired rooms.

The appliance has four ventilation levels. The air flow rate can be adjusted for each ventilation level. The constant volume control system ensures a balanced airflow between the supply and exhaust fan independent of the duct pressure.

If no external control is connected to the appliance, then the appropriate ventilation level can be chosen on the touchscreen display. For external control a 4-way switch (→ Connecting extra multiple switch with filter indication page 36) can, for example, be chosen, but control is also possible with the Air Control (→ Connecting Air Control page 41), CO<sub>2</sub> sensor(s) (→ Connecting CO<sub>2</sub> sensor(s) page 43), a humidity sensor (→ Connecting humidity sensor page 42) or the App.

## 4.2 Bypass

The 100% bypass function ensures that the extract air flows past instead of through the heat exchanger, so that cooler supply air is not heated. Particularly during summer nights it is desirable to supply cooler outside air. The bypass valve opens and closes automatically when a number of conditions are met (see table below for bypass conditions). Follow step numbers 2.1 to 2.6 in the settings menu in the user interface, (→ Setting values standard appliance page 50) in order to adjust the operation of the bypass valve.

### Automatic bypass control strategy

<b>Bypass valve open</b>	<ul style="list-style-type: none"><li>▪ The outdoor temperature is higher than 10°C (adjustable between 7°C and 15°C at step no. 2.3) <b>and</b></li><li>▪ the outdoor temperature is lower than the indoor temperature of the dwelling <b>and</b></li><li>▪ the temperature from the dwelling is higher than 24°C (adjustable between 15°C and 35°C at step no. 2.2)</li></ul>
<b>Bypass valve closed</b>	<ul style="list-style-type: none"><li>▪ The outdoor temperature is lower than 10°C (adjustable between 7°C and 15°C at step no. 2.3) <b>or</b></li><li>▪ the outdoor temperature is higher than the indoor temperature of the dwelling <b>or</b></li><li>▪ the temperature from the dwelling is lower than the set temperature at step no. 2.2 in the settings menu minus the set temperature at the hysteresis (step no. 2.4).</li></ul>

The appliance features a 'Bypass boost' function. When activated (step 2.5), the appliance is set to the highest ventilation level as soon as the bypass opens. (adjustable at step no. 2.6).

## 4.3 Frost protection

To keep the heat exchanger frost-free at low outdoor temperatures, the appliance features a frost control.

Temperature sensors measure the temperatures in the appliance, when required the preheater gets activated. The unit will also detect, very low outdoor temperatures at which the capacity of the preheater will be insufficient. At this stage an imbalance strategy will be activated where surplus warm extract air is used.

The software 'recognizes' the appliance.

## 4.4 Optional Plus pcb

All standard appliances can be modified into a Plus version using the Plus pcb upgrade set.

The appliance equipped with this optional control board (Plus pcb) has more connections for various applications.

This extra control board can be fitted behind the existing control board on top of the appliance.

It is also possible to mount the Plus pcb with its casing on a wall near the appliance; this can be helpful in circumstances such as a poor WiFi signal.

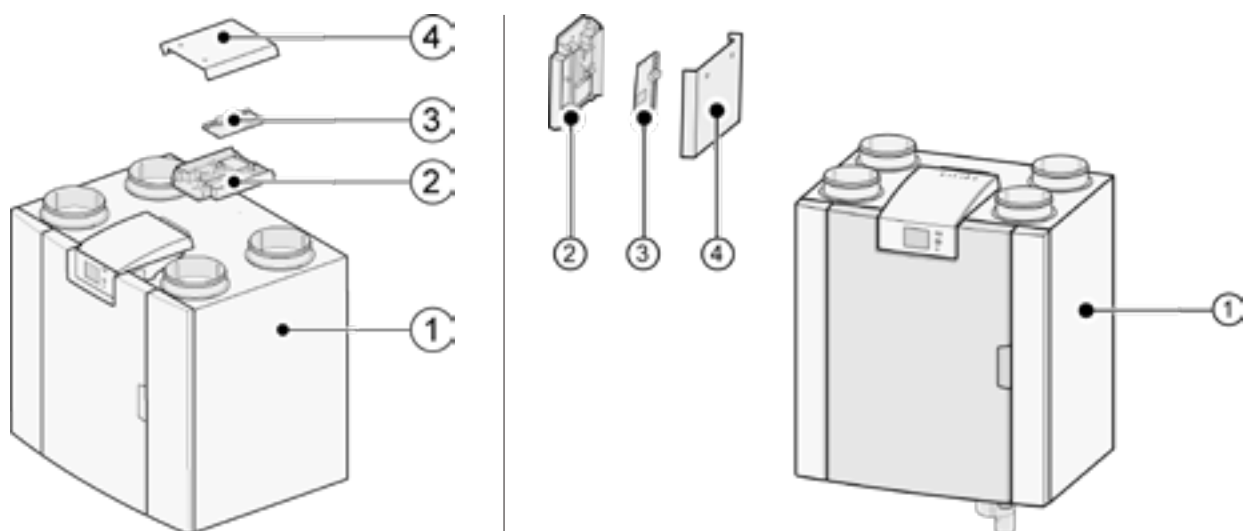

1. For example a Ubiflux Vigor appliance with mounted Basic pcb
2. Optional Plus pcb mounting plate
3. Optional Plus pcb
4. Optional Plus pcb cover

# 5 Installation

## 5.1 Installation general

Installing the appliance:

1. Placing the appliance (→ Placing the appliance page 13 )
2. Connecting the siphon and condensate discharge (→ Connecting the condensate discharge page 14)
3. Connecting the air ducts → Connecting air ducts page 15)
4. Electrical connections (→ Electrical connections page 16)

The installation and installing should meet the following requirements:

- Quality requirements of ventilation systems in homes, ISSO 61.
- Quality requirements of balanced ventilation dwellings, ISSO 62
- The regulations for ventilation of dwellings and residential buildings.
- Safety provisions for low-voltage installations
- The regulations for connecting indoor plumbing in homes and residential buildings.
- Any additional regulations of the local utilities.
- The installation regulations for the Ubiflux Vigor W600.
- In addition to the above design and installation requirements and recommendations, the national building and ventilation regulations must be respected.

## 5.2 Placing the appliance

The Ubiflux Vigor W600 (can be mounted onto a wall with the supplied mounting bracket. For a vibration-free installation, the appliance must be mounted to a solid wall with a minimum mass of 170 kg/m<sup>2</sup>. A gypsum- or drywall will not suffice! Additional measures such as double panelling or additional studs are required in that case. Alternatively, a mounting support for floor mounting (with the same minimal mass) is available.

In addition, the following aspects must be taken into account:

- The appliance must be installed in an insulated frost-free room (> 10 °C), in order to, for example, prevent freezing of the condensate discharge.
- The appliance must be placed level.
- The appliance must not be placed in a room with a high level of condensation (such as a bathroom).
- In order to prevent condensation on the outside of the appliance, the installation room must be ventilated.
- The installation room must be able to provide a condensate discharge with a sufficient water seal and drop for the condensed water.
- Newly built houses with a lot of moisture from the construction work need to be ventilated in a natural manner before putting the appliance into use.
- Make sure there is a free space of at least 70 cm at the front of the appliance and a free headroom of 1.8 m.
- Make sure there is a free space of at least 25 cm above the appliance, for connecting the appliance and any necessary servicing of the circuit board. The ambient temperature has to be between +10 °C and + 40 °C.

## 5.3 Connecting the condensate discharge

The condensate discharge line for the Ubiflux Vigor W600 is located in the lower panel. The condensate is discharged through the drainpipe. The siphon (with built-in air vent) is supplied separately with the appliance and must be fitted by the installer below the appliance (bayonet connection). The siphon has an external connection diameter of 32 mm. The siphon is connected to the inner sewer system. It is recommended to fit an odor trap between the sewer system and siphon in order to avoid unpleasant odors.



### Important :

With the Ubiflux Vigor W600 appliance as the left-hand version, the condensate discharge connection is located at the right side of the bottom panel and with the Ubiflux Vigor W600 appliance as the righthand version, the condensate discharge connection is located on the left of the bottom panel (→ Connecting the condensate discharge page 14, Connections and dimensions page 8 ) Never switch the two condensate discharge connections below the appliance! Never remove the sealing cap from the unused condensate discharge connection!

It is recommended to use a 32 mm connection with gasket (HT DN32) (not supplied with the appliance) so that the siphon can be cleaned easily in the future.



### Important :

During assembly always apply a lubricant, such as acid-free vaseline, to the rubber sealing ring in the gasket. This gasket connection has to be disconnected when servicing the appliance! The siphon must not be glued to the condensate discharge line!

The condensate discharge can be connected, for example, with a straight or angled connection with gasket. Slide the condensate discharge connection with gasket with sufficient length across the connection of the siphon.

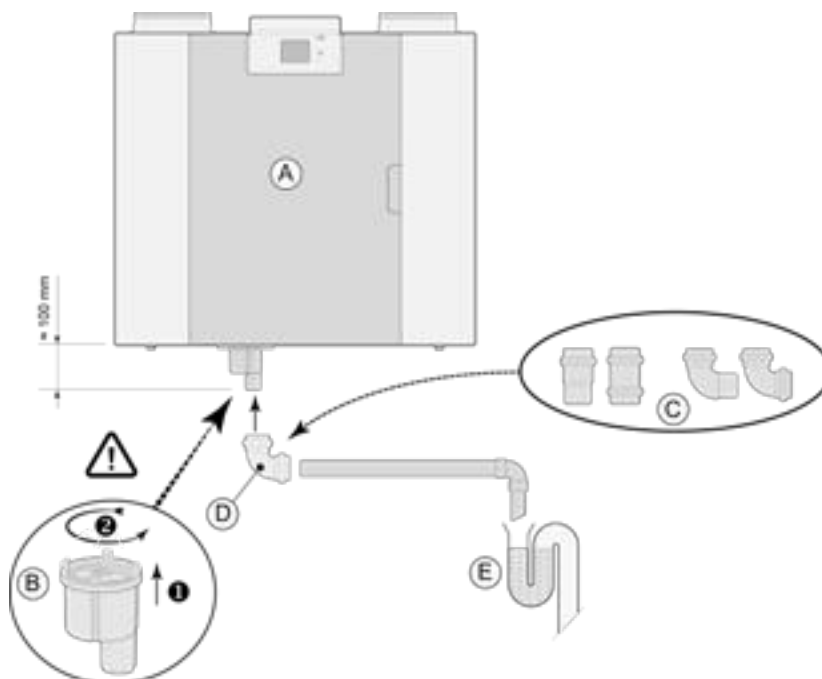

A = For example a Ubiflux Vigor right-hand version

B = Fitting siphon below in Ubiflux Vigor appliance

C = Examples with condensate discharge connections with gasket HT DN32

D = Detachable connection

E = Example of odor trap

## 5.4 Connecting air ducts

All air ducts must be installed airtight. The collars on the Ubiflux Vigor appliance are provided as standard with sealing rings.

In order to prevent condensation on the outside of the outdoor air supply duct and the air exhaust duct from the Ubiflux Vigor appliance, the ducts have to be provided with an external vapor barrier as far as the appliance. If thermally insulated piping is used here, additional insulation is not necessary.

For compliance with the maximum installation noise level of 30 dB(A), it will have to be assessed for every installation what measures will be required to limit the noise. In order to optimally dampen the noise of the fans from and to the dwelling through the duct, at least mufflers of no less than 1 m are required, but additional measures may be necessary.

Prevent crosstalk through the air supply and discharge ducts by using separate branches to the diffusers. If necessary, the supply ducts must be insulated, for instance when they are installed outside the insulated envelope.

The outdoor air supply should ideally be placed at the shadowed side of the dwelling, preferably from the wall or an overhang.

The exhaust duct must be fed through the roof boarding in such a way that no condensation forms in the roof boarding.

The exhaust duct between the Ubiflux Vigor appliance and the roof terminal should be such that surface condensation is prevented.

Always use an insulated ventilation roof terminal.

In order to reduce noise levels,, it is recommended to restrict the external duct pressure to 100 Pa. If the resistance of the duct system is higher than the maximum curve of the fan, the maximum fan capacity will be lower.

The air speeds in the ducts must be limited to the following maximum values:

Type of ducts	Maximum Air Speed [m/s]
Collective duct	5
Main duct	4
Duct branch: supply	3
Duct branch: outlet	3,5

The location of the Exhaust air outlet and the sewer stack vent must be chosen to prevent noise nuisance.

The location of the supply valves must be chosen in such a way to prevent fouling and drafts. We recommend using Ubbink supply valves.

When using flexible mufflers, account must be taken during the installation that these may need to be replaced after a period of time.

Ensure sufficient overflow openings. For example a gap of 2 cm underneath the doors.



**Important :**

When installing and maintaining the unit (see → Maintenance installer page 32 ), check that no dust or dirt has accumulated on the preheater! Clean the preheater well during maintenance.

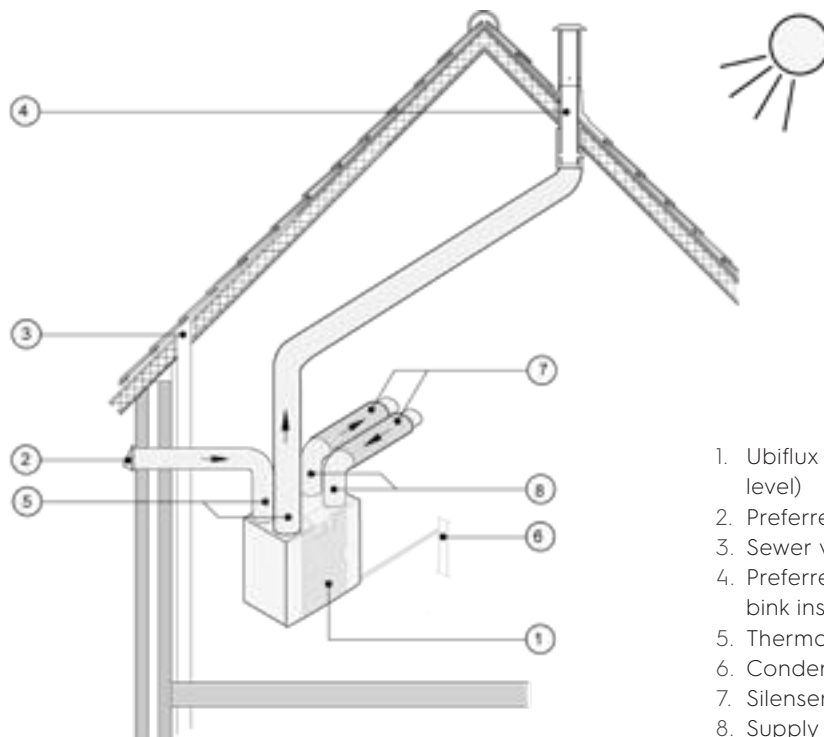

1. Ubiflux Vigor W600 right-hand version (place level)
2. Preferred location outdoor air inlet
3. Sewer vent
4. Preferred location Exhaust air outlet; Use Ub-bink insulated ventilation roof terminal
5. Thermally insulated ducts
6. Condensate discharge
7. Silencers
8. Supply air and extract air ducts

## 5.5 Electrical connections

### 5.5.1 Connecting the power plug

The appliance should be connected to an easily accessible, earthed wall socket with the plug that is mounted to the appliance. The electric installation must comply with the requirements of your power company.

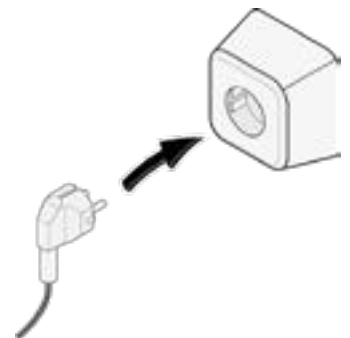

### 5.5.2 Connecting the multiple switch

The multiple switch (not supplied with the appliance) is connected to the modular connector type RJ12 (connector X14) which is located on the rear of the display cap of the appliance (→Exploded view of appliance page 17). For connection examples of multiple switch (→Connecting multiple switch page 17). A wireless remote control →Connecting wireless remote control (without filter indication) page 38) and a combination of multiple switches is also possible (→Connecting extra multiple switch with filter indication page 39). The 4-way switch can also be used to activate a 30-minutes boost mode by putting the switch to setting 3 for less than 2 seconds and directly turning it back to setting 1 or 2. The boost mode can be reset by putting the switch to setting 3 for longer than 2 seconds or by switching it to absence mode ( **FAN** ).

### 5.5.3 Connecting an eBus accessory

For connecting an eBus accessory, use the, the 2-pole detachable (green) connector X17 located at the rear of the display cover (→ Exploded view of appliance page 47). The eBus protocol may for instance be used to connect the Air Control (→ Connecting Air Control page 41). This connector is polarity sensitive. The connection will not work if the wires are connected to the wrong screw terminals! The optional CO2 sensor(s) or an extra eBus preheater or postheater (→ Electrical diagram page 34) can also be connected onto the eBus connector.

### 5.5.4 24 volt connection

The appliance features two, (black) 24 volt outputs (X16 & X18) which can be used to power accessories. Connector X-16 is for 24 volt connection of the optional Plus pcb. The maximum power is 5 VA per output.

### 5.5.5 Connecting humidity sensor

The optional humidity sensor has to be connected onto the the X07 connection of the basic pcb. Use the cable supplied with the humidity sensor. In order to connect the humidity sensor, the cover above the control has to be removed., after which the X07 connection is accessible. For connecting the humidity sensor, see → Connecting humidity sensor page 42.

### 5.5.6 Connection internal Bus

The Modbus/ internal bus (red) connector X15 can for example be used for coupling appliances (→ Coupling appliances using internal Bus page 18).

he function of this connector can be adjusted using step number 14.1 to 14.4 in the settings menu. If the appliance is fitted with a Plus pcb, then this red connector X15 is also in use for connecting the Plus pcb; several cables then have to be connected onto this connector X15.

### 5.5.7 Connecting "signal output" connector

The blue 2-pole screw connector X19. This connection is used to give a filter message or fault message. If a filter or fault message is given in the appliance a contact is closed at connection X19. The operation of this is set by following step number 16.1.

### 5.5.8 ModBus Connection

The appliance can be connected with a ModBus system such as a building management system. Using the (red) 3-pole connector X15 (or with the Plus version the red connector X06 on the UWA2-E pcb) a connection can be made between the appliance and the ModBus system; (→ Electrical diagram page 34) for the right connection. For the correct setting of the jumpers X12, X121 & X122 see the explanation given with electrical diagram → Electrical diagram page 34); for more information and the correct modBus settings see the separate Modbus manual on the Ubbink website!

**Note:** When ModBus is active, the ventilation mode cannot be changed using the display or, if applicable, the connected multiple switch! Also any connected humidity sensor will not function.

### 5.5.9 Coupling appliances using internal Bus



**Important :**

Because of polarity sensitivity, always connect the internal Bus contacts X15-1 with one another, and the contacts X15-2 and the contacts X15-3 with one another. Never connect X15-1, X15-2 or X15-3 with one another!

**Comment:** If a Plus pcb has been installed; several cables would have to be connected onto the X-15 connector.

**Note :** When the total length of the internal Bus cables is longer than 10 m, then use a twistedpair cable for connection X15-2 & X15-3 (a twisted pair cable is also preferred with shorter lengths)!

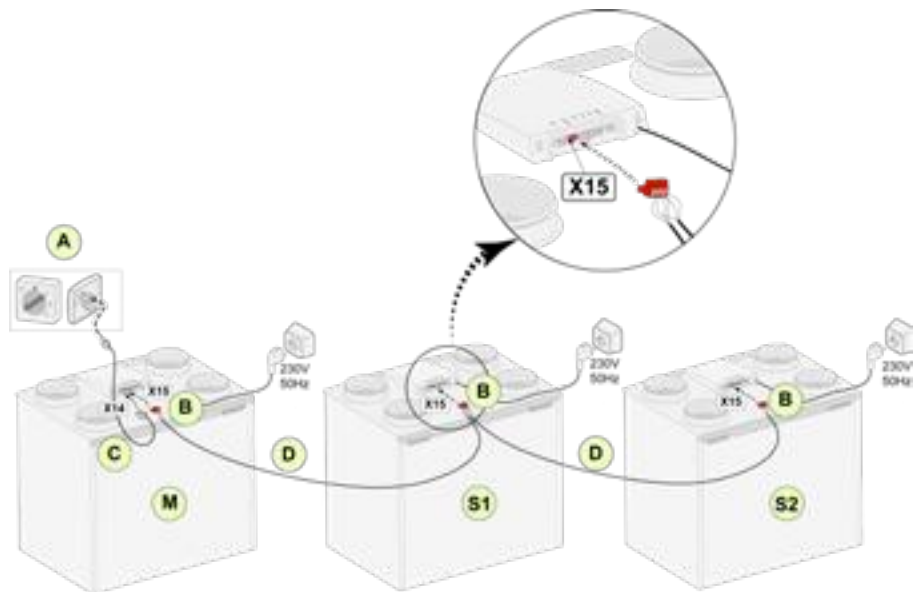

For M (master):  
Step no. 8.1 - Master  
Step no. 14.1 - internal Bus

For S1 (Slave 1):  
Step no. 8.1 - Slave  
Step no. 14.1 - internal Bus

For S2 (Slave 2):  
Step no. 8.1 - Slave  
Step no. 14.1 - internal Bus

A = Multiple switch

B = 3-pole connector red

C = Modular cable

D = 3-core low voltage cable

M = Master appliance (For example a Ubiflux Vigor appliance type 4-0)

S1 / S2 = Slave appliances (For example a Ubiflux Vigor appliance type 4-0); connect max. of 10 appliances via internal Bus.

All Ubiflux Vigor W600 appliances have the same air flow rate as the appliance that is set as "Master". The fault messages of all appliances are shown on the display of the master appliance and shown on the display of the relevant appliance. When using a Air Control or the Home, always connect this to the Master. After connecting the cables configure each Ubiflux Vigor W600 appliance:

- Enable "internalBus" in menu 14.1 "Type of Bus connection" where shortly after the network symbol appears.
- Configure each slave in menu 8.1 "Appliance setting slave 1, slave 2 etc where shortly after the M symbol appears on the master appliance and S1, S2 symbol on slave appliances
- Power down and up all appliances.

Note : Any accessory such as moisture sensor, position switch, extension board or any eBus device must be connected to the Ubiflux Vigor W600 maître.

# 6 Display

## 6.1 General explanation of control panel

A display with touchscreen is located at the front of the appliance. This display is used to operate the appliance and to provide the user with information about the status of the appliance. When the mains power is switched on, the software version is first shown; the main screen is then displayed.

### Main screen



1. Current time
2. Info connections (only displayed if applicable)
3. Current date
4. Set ventilation flow rate; the red bars indicate the selected ventilation flow rate. In this example the active ventilation flow rate is 100 m<sup>3</sup>/h
5. Active control
6. Filter message (only displayed if applicable)\*
7. Fault (only displayed if applicable)\*
8. Access to settings menu
9. Access to information menu

\* Filter message and fault message are located in the same place on the display; fault display has a higher priority, and so will always be shown first even when there is an active filter message!

The factory setting of the menu is English. The desired language/ date & time can be modified in the settings menu ; for this, please refer to the settings value table (\* Setting values page 50) step number 15.1 to step number 15.10.

## 6.2 Display layout

The screen is divided up into 6 zones where various symbols/displays can be shown per zone.



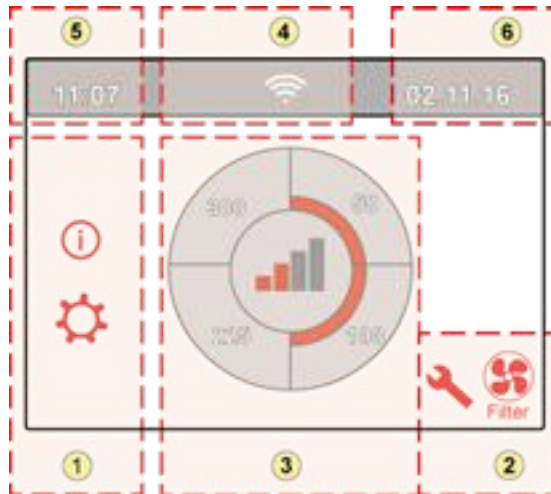









### Layout of main screen





1. Navigation screen
2. Notification screen
3. Screen with main function
4. Connectivity information
5. Time
6. Date

The various symbols can be shown on the display. This depends on the screen that is shown, the version of the appliance and any connected accessories.



Zone n°	Symbol on display	Description
1		By pressing here you get access to the information menu; here one can only read out values. It is not possible to change these values.
		By pressing here you get access to the settings menu. In this menu you can change the various values. For all setting values of standard appliance (→ Setting values standard appliance page 50). The Plus version of the appliance has various setting values (→ Setting values appliance with Plus pcb page 53). Caution: Incorrect settings can disrupt the operation of the appliance!
		Use these arrows to go up or down the various menus or to increase or decrease the values of the relevant settings.
		This arrow takes you back one step in the menu.
		This takes you back to the main screen.
2		Filter message symbol; this is only shown if the filter has to be cleaned or replaced. See chapter "Filter cleaning" (→ Cleaning filters page 29) for more information.
		This symbol is only shown if a fault has occurred in the appliance; see chapter Faults ( Fault analysis page 26) for more information.

Zone n°	Symbol on display	Description
3		Control using multiple switch.
		Control by means of Home.
		Control using touchscreen on appliance; this setting is active for half an hour.
		Control using touchscreen on appliance; touchscreen is permanently set as multiple switch by setting step number 15.8 to "yes".
		Control using humidity sensor.
		Control using CO2 sensor.
		Control using demand-driven ventilation.
		Break contact active or make contact active.
		This appliance is set as Master appliance if a number of appliances are connected (cascade)
		Appliance is set as Slave appliance; maximum of 9 appliances can be connected to a Master.
		Control via eBus for example Air Control .
		Control via ModBus or internal Bus.
		Bypass boost is active.

Zone n°	Symbol on display	Description
4		Internet connection/Network connection
		Signal strength
		USB connection active.
5	11:07	Current set time of the device.
6	02.01.2020	Current date.

## 6.3 Display information

When no keys are operated or when no deviating situation has developed (such as fault message or filtermessage) then the light will go out two minutes after the last key has been operated. When there is a filter message or a fault in the appliance, then the light of the display will be on permanently until the fault has been solved or the filter message has been reset.

Pressing the Home button  brings you back to the main screen from any particular menu; pressing the return button  takes you back 1 step in the menu.

Briefly press the display (shorter than 5 seconds) to switch on the display backlight without changing anything in the menu; the display lights up for 2 minutes.



By pressing one of the quarter circles on the main screen, the ventilation mode can be quickly adjusted. The ventilation mode that has been set in this way remains active for half an hour; this is visible on the display by a hand with a clock.



The touchscreen can also be permanently set as multiple switch; to do this step number 15.8 in the settings menu has to be set to "yes".



**Warning:**

Incorrect settings can seriously disrupt the proper functioning of the appliance!

# 7 Starting appliance

## 7.1 Switching appliance on and off

### Switching on:

Switching on the mains power:

1. Connect the 230 V power plug to the electric system.
2. During the startup of the appliance, the version of the software is displayed. If the appliance has been without power for a long time (more than approx. 1 week), you will have to reset the correct language, time and date in setting menu .
3. The appliance will then operate immediately after this according to the mode of the multiple switch. If no multiple switch is connected then the appliance operates always in mode 1.

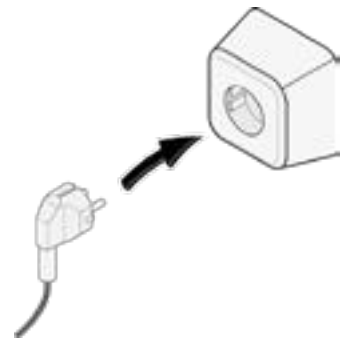

### Switching off:

Switching off mains power:

1. Pull the 230 V power plug from the electric system; the appliance is now free of voltage.
2. Nothing is now shown on the display.

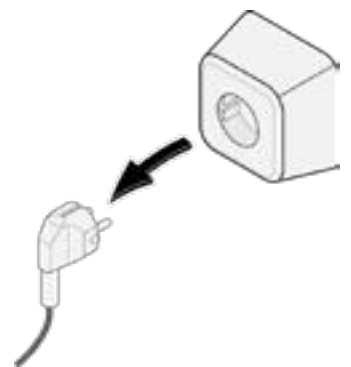

#### Warning!

When working on the appliance, always first take the voltage from the appliance by pulling the power plug.

## 7.2 Setting the air flow

Good ventilation contributes to healthy air in the home, optimal comfort and the proper functioning of the installation.

The air Flows of the appliance Ubiflux Vigor W600 have been set in the factory as follows 100, 150, 300 and 500 m<sup>3</sup>/h. The performance and the energy consumption of the appliance depend on the pressure drop in the duct system, as well as on the filter resistance. If these conditions are not complied with, the air flow rate of the higher mode will automatically be adjusted.

Changes can be carried out in the settings menu . Go in the settings menu to steps 1.2 to 1.4 to adjust the air flow.

### Please note!

The highest demanded ventilation mode has priority. If the external multiple switch is set to mode 3, then the ventilation mode cannot be adjusted to a lower mode on the main screen. An exception to this is ventilator mode 0. If mode 0 is chosen on the display: control from other switches, sensors, etc. is not possible.

For connected CO2 sensors the air flow will be steplessly controlled between mode 1 and 3 depending on the measured PPM values: for a connected humidity sensor the air flow will be switched to mode 3 when this is switched on.

## 7.3 Other settings for installer

In addition to the air flow, it is also possible to change other settings of the appliance; for an overview of these settings of a standard appliance (→Setting values standard appliance page 50) and appliance with Plus pcb (° Setting values appliance with Plus pcb page 53). Changes can be carried out in the settings menu .



**Warning:**

As changes in the settings menu can disrupt the proper functioning of the appliance, changes of settings not described here require consultation with Ubbink nv. Incorrect settings may seriously affect the proper performance of the appliance!

## 7.4 Factory settings

It is possible to simultaneously revert all the changed settings back to the factory settings. All changed settings are then back to the values they had when they left the factory; all message and fault codes are also deleted from the service menu.

**The filter message, however, is not reset!**

For returning to factory settings, open the settings menu .

Under appliance settings, the appliance can be returned to factory settings through step number 15.9.



**Caution!**

After resetting to the factory setting, step number 14.1 must be reset to internal Bus in the settings menu! Interne dans le menu des réglages !

# 8 Fault

## 8.1 Fault analysis

When the appliance's control system detects a fault, this is indicated on the display by a spanner symbol, possibly also with a fault number.

The appliance makes a distinction between a fault at which the appliance keeps running (limitedly) and a serious (locking) fault for which both fans are switched off.

## 8.2 Display Codes

### Non-locking fault

When the appliance detects a non-locking fault, it will keep running (limitedly). The (permanently lighted) display shows the fault symbol. Press the fault symbol for an explanation/ solution to the fault.



The screen can be left by pressing the "Home" button. If a fault cannot be solved, please contact the installer.



1. Requested supply flow rate is not reached

### Locking fault

When the appliance detects a locking fault, it will no longer work. With a locking fault the settings and information menu are also switched off.

The (permanently lighted) display shows the fault symbol (spanner) together with a fault code. The red LED on the multiple switch (if applicable) will be blinking. The appliance remains in this fault mode until the problem in question has been solved. Then the appliance will reset itself (Auto reset) and the display returns to the display of the operating situation. Contact the installer to remedy this fault.



1. Supply fan defective

**A locking fault cannot be remedied by taking the voltage from the appliance; first the fault has to be solved.**



**Warning!**

When working on the appliance, always first take the voltage from the appliance by pulling the power plug.

In the table below the locking faults are marked with an \* after the fault number. The display shows a brief explanation of this fault code. If there is reference to the "Standby" mode of the appliance, then both fans are shut down but there is still something shown on the display of the appliance.

Fault code	Sub code	Cause	Appliance action	User action
E190	E1000	Self-test not good	No action	
E152*	E1001 *	Flash memory faulty	Stop appliance if possible	Replace basic pcb UWA2-B
E153	E1002	EEPROM memory defective	Appliance goes to factory setting; fan setting 2	Replace basic pcb UWA2-B
E105	E1011	Requested supply flow rate is not achieved	None	Clean or replace filters Check that ducts are not blocked
E104	E1012	Requested exhaust flow rate is not achieved	None	Clean or replace filters Check that ducts are not blocked
E000*	E1013 *	Temperature of outside air too high	Appliance goes to standby	Depending on the situation: In the event of warm weather and a supply directly below the tiles, wait until the air has cooled or install a roof sleeve instead of duct under the tiles In the event of cold weather or when there is no air from below the tiles, take the voltage from the appliance and replace air temperature sensor (NTC)
E105*	E1100 *	Supply fan defective; general message	Appliance goes to standby	Replace supply fan Fault is reset automatically when voltage is put back on appliance.
E104*	E1120 *	Exhaust fan defective; general fault message	Appliance goes to standby	Replace exhaust fan Fault is reset automatically when voltage is put back on appliance.
E103	E1200	Bypass defective; general fault message	None	Check wiring Replace bypass or wiring harness
E106*	E1300 *	Sensor NTC1 defective; general fault	Appliance goes to standby	Check wiring Replace NTC sensor or replace wiring
E111	E1400	RHT sensor 1 defective; general message	No humidity control	Check wiring Replace RHT sensor or replace wiring
E113	E1600	Internal preheater defective; general fault message	Frost protection goes to imbalance mode	Check fuses Check wiring; replace if damaged and replace otherwise the internal preheater Fault is automatically reset when the voltage is put back on the appliance.
E115	E1500	Multiple switch defective; general fault	Appliance goes to mode 1	Replace multiple switch
E130	E1800	Relay output 1 defective; general fault	Signal output not available	Take voltage from appliance Replace UWA2-B pcb Fault is automatically reset when voltage is again put back on appliance.
E1155	E2000	Touchscreen fault; general fault message	Fault codes only visible when using service tool	Check wiring to touchscreen; replace wiring if damaged; replace touchscreen if fault still occurs replace UWA2-B Fault is automatically reset when voltage is again put back on appliance

Fault code	Sub code	Cause	Appliance action	User action
E120	E2100	EBus fault; general fault message	Air Control and other accessories connected to eBus do not work. Appliance is working	Check wiring to accessories/ Air Control Check accessories/Air Control and replace if defective If there is still a fault after this: Take voltage from appliance and replace basic pcb UWA2-B
E121	E2200	internal Bus general fault message	Air Control and other accessories do not work. Appliance is working	Check wiring to accessories/ Air Control Check accessories/ Air Control and replace if defective If there is still a fault after this: Take voltage from appliance and replace basic pcb UWA2-B
E122	E2300	Internal ModBus fault; general fault message	Appliance goes to standby	Check wiring and connections to UWA2-B and the fans Replace cable harness if damaged; Then exchange UWA2B, exhaust fan and supply fan
E123	E2400	External ModBus fault; general fault message	Operation via Modbus does not work	Check cabling of accessories; replace if damaged Check accessories; replace if defective If fault still occurs: Take voltage from appliance and replace UWA2-B basic pcb
E124	E2500	USB port general fault message	USB interface not usable	Replace USB accessory If the fault is not remedied after this: take the voltage from the appliance and replace UWA2-B basic pcb
E170	E2600	One or more CO2 sensor(en) defective; general fault message	Appliance is working; no CO2 regulation	Check cabling and CO2 sensor(s); replace if damaged Check CO2 sensor(s); replace if defective
E171	E2700	External preheater or fuse defective; general fault message	No preheater / comfort control responds differently	Uncouple preheater and check preheater fuse; replace fuse if defective Has the fault not yet been remedied: Replace external preheater Put voltage back on appliance Fault has automatically been reset
E172	E2800	External postheater or fuse defective; general fault message	No postheater / comfort control responds differently	Uncouple postheater and check postheater fuse; replace fuse if defective Has the fault not yet been remedied: Replace external postheater Put voltage back on appliance Fault has automatically been reset

# 9 Maintenance

## 9.1 Cleaning filters

The maintenance for the user is limited to the periodic cleaning or replacement of the filters. The filters only has to be cleaned if this is indicated on the display (the filter symbol is shown here)  or, if a multiple switch with filter indication has been installed and the red LED of the switch is on. The filters should be replaced every half year.

After the filters has been cleaned 1 time, they must be replaced.

The appliance must never be used without filters.



### **Cleaning and replacing the filters:**

Press the filter symbol  for longer than 3 seconds to open the filter wizard.

Now follow the instructions that appear on the display to clean and/or replace the filters. This filter wizard cannot be interrupted.

When all the instructions on the menu have been followed and confirmed, then the filter wizard is closed by pressing  the "Home" button and the display then returns to the main screen; the filter message is reset and the filter message now disappears.

### **Comment:**

If the filter wizard is opened in order to replace the filters whilst there is no filter message on the display screen, go in the settings menu  to step number 4.2 to open the filter wizard. Now follow the instructions on the display, and once finished the timer of the filter message is reset. It is also possible to go in the settings menu using step number 4.3 to reset the filter directly without opening the filter wizard; if "Yes" is chosen then in the settings menu this step number has to be left again by pressing "Home" button  or the "return" button .

The timer of the filter message is then reset!

Pressing the Home button  brings you back to the main screen from any particular menu; pressing the return

button , takes you back 1 step in the menu.

## 9.2 Maintenance siphon

### Cleaning the siphon

Every year the siphon must be disconnected and cleaned.

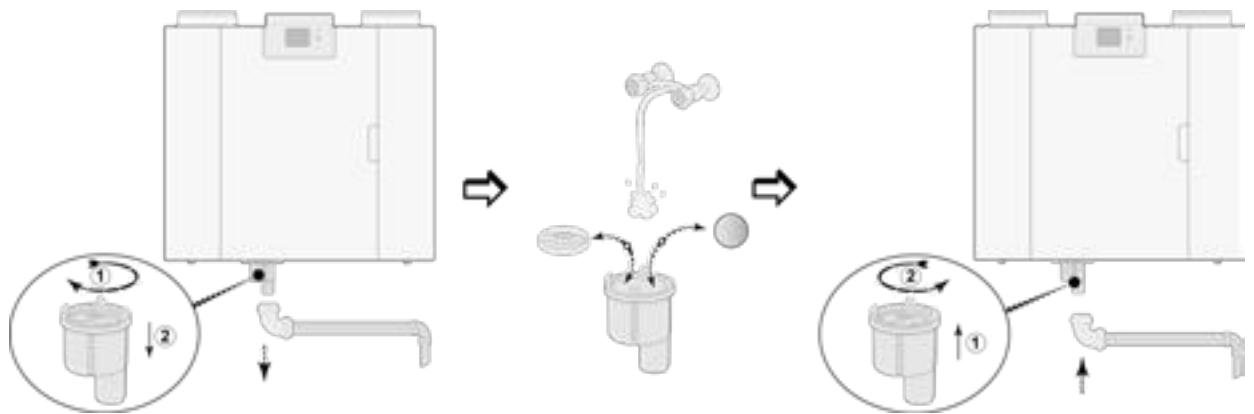

(For example a Ubiflux Vigor appliance type 4-0).

## 9.3 Maintenance installer

Installer maintenance includes cleaning the heat exchanger, internal preheater and fans. Dependent on the conditions, this must be done about once every three years.

1. Remove the power supply by pulling out the plug. Open the filter door.

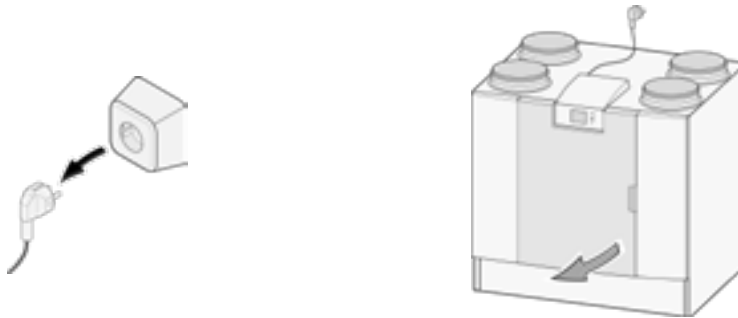

2. Remove the two filters.

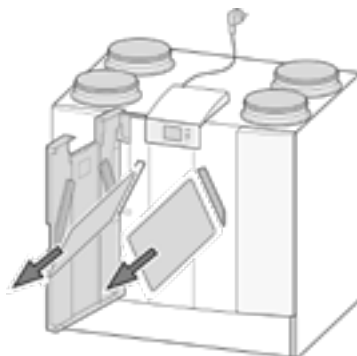

3. Remove the front cover.

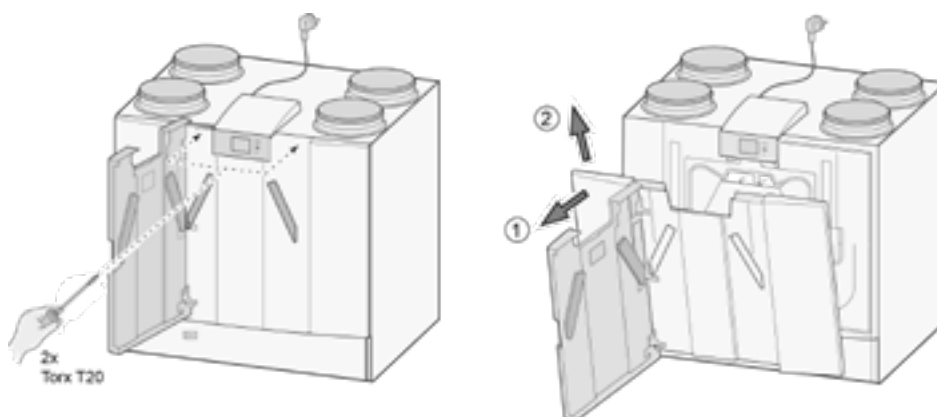

4. Remove the heat exchanger. Be careful not to damage the foam parts in the appliance.

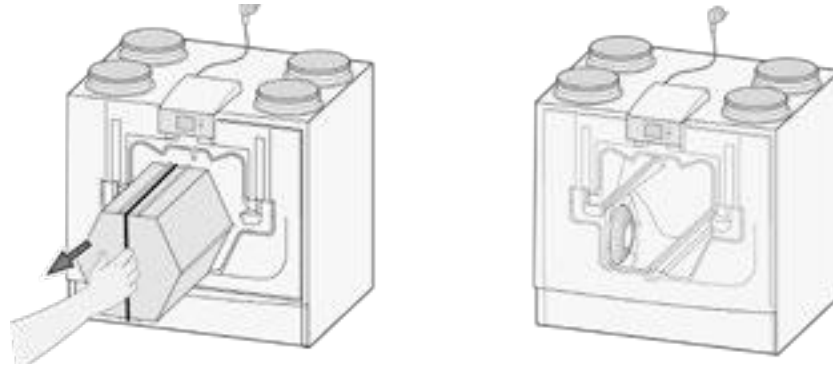

5. Wash the heat exchanger with hot water (max. 45°C) and a regular detergent. Then rinse the exchanger with hot water.

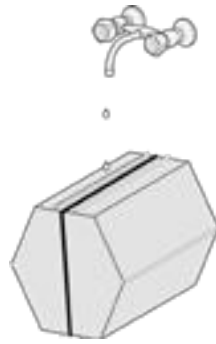

6. Take EPS assembly, with which the fan is inserted into the appliance, out of the appliance.

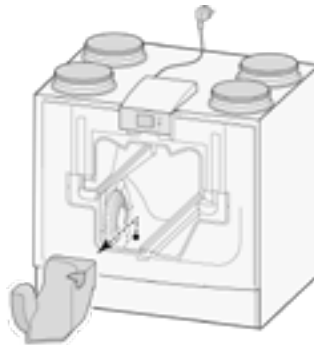

7. Turn the fan a quarter of a revolution in the appliance.

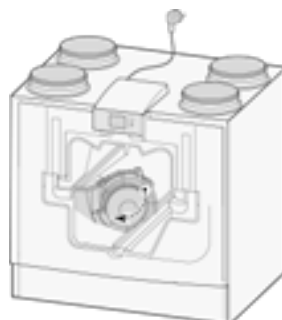

8. Tilt the fan in such a way that this can be taken out of the EPS assembly; disconnect both fan cables from the fan.

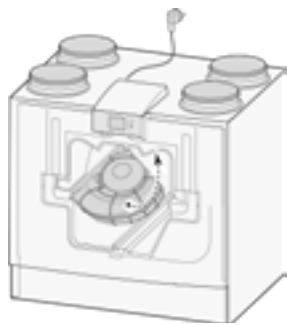

9. Now take the fan out of the appliance.

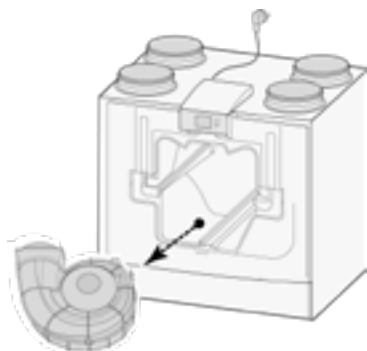

10. Repeat steps 6 to 9 for the other fan in the appliance.
11. Carefully clean both fans with a soft brush; do not use any water or cleaning agent.
12. Clean the internal preheater (for location see → Service articles page 48 ) .
13. Place both fans back in the appliance and connect the disconnected fan cables once more; when doing so, take care that the fan cables are "behind" the fans and that the fans are returned to their original position. The left fan is indicated by "Left"; the right fans is indicated by "Right".  
**Comment: Do not change the position of the fans!!**
14. Slide the cleaned heat exchanger carefully back into the appliance; when doing so, take care that the EPS parts and rails in the appliance are not damaged, which could otherwise leads to internal leaks in the appliance. Take care when returning the heat exchanger that the text on the type plate is not upside down! Place the heat exchanger back such that this type plate is visible.
15. Put the front cover back on and screw it secure.
16. Install two new filters and close the front cover.
17. Reconnect the 230V power supply to the appliance.
18. Reset the timer of the filter message by setting the timer back to zero in the settings menu at step number 4.3.
19. After resetting the timer of the filter message the appliance returns to the main menu and the appliance is once again ready for use.

# 10 Electrical diagram

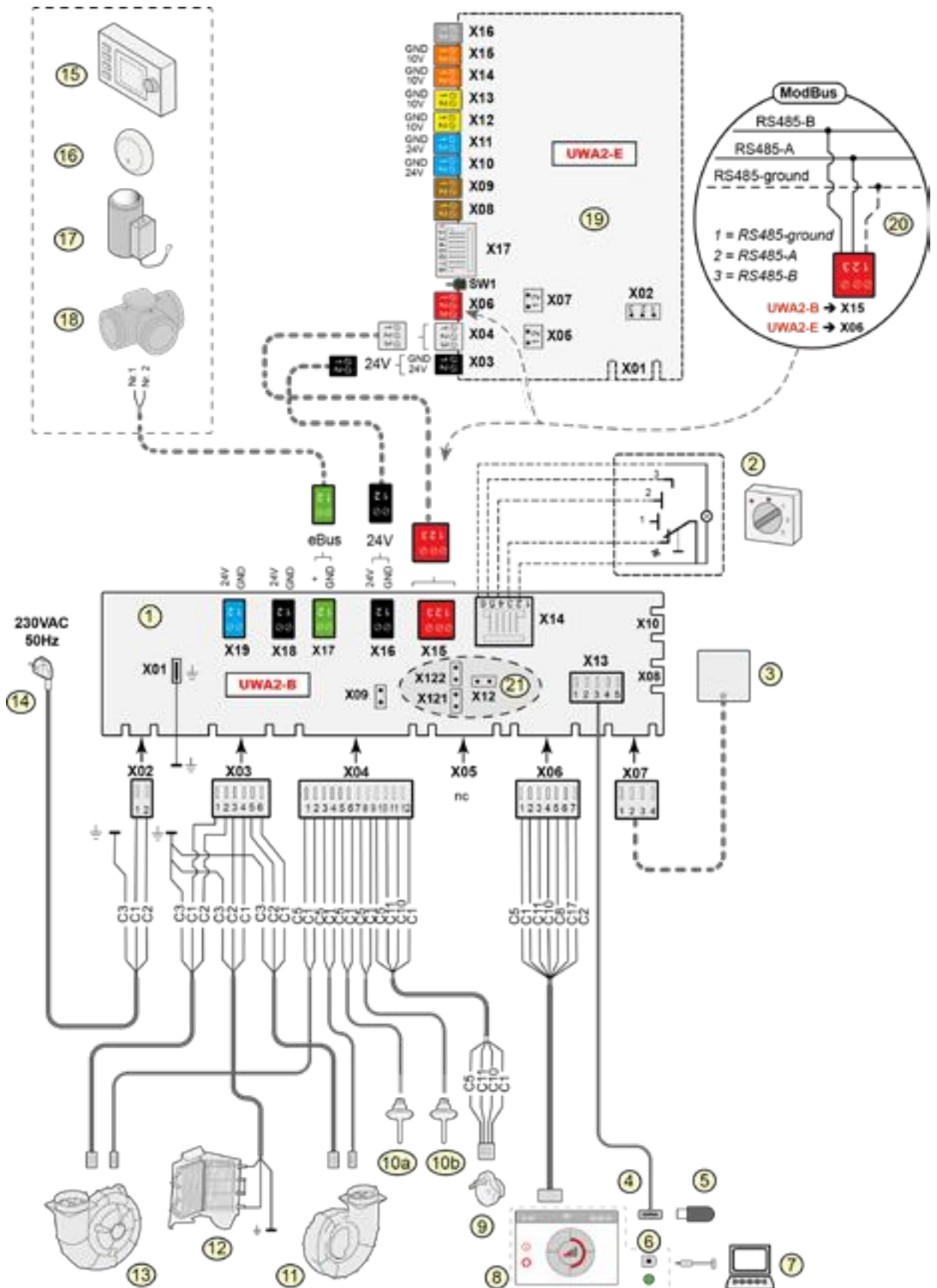

- 1 = Basic pcb
- 2 = Multiple switch (option)
- 3 = Humidity sensor (option)
- 4 = USB connector
- 5 = USB stick for updating software (not supplied with appliance)
- 6 = Service connector
- 7 = Laptop with installed service tool (not supplied)
- 8 = Touchscreen on appliance
- 9 = Valve motor bypass valve
- 10a = Air temperature sensor NTC1
- 10b = Air temperature sensor NTC2
- 11 = Exhaust fan\*
- 12 = Internal preheater incl. maximum security
- 13 = Supply fan\*
- 14 = Power supply 230V 50Hz
- 15 = Air Control (option)
- 16 = CO2 sensor eBus (option)
- 17 = Heater eBus (option)
- 18 = Not applicable for Vigor W600
- 19 = Plus pcb (option)
- 20 = Connection on ModBus system (option)
- 21 = X12 is Jumper terminating resistance (120 W) ModBus (remove if terminating resistance has already been placed in ModBus system). With Modbus application remove the jumpers X121 & X122; when using internal Bus place the jumpers X12, X121 & X122; remove Jumper X07 from Plus pcb when a Plus pcb is applied.

\* The control cables of the fans can be switched with no problem; when the power is switched on the appliance determines itself which is the supply and exhaust fan! When the appliance detects another fan (for example when a fan is replaced during service activities), then a "wizard" starts up automatically; follow the instructions on the display for the correct connection of the fan cables. The position of the fans in this diagram is for illustration purposes only. Installation position depends on the type of appliance.

### Basic pcb

- X15 = internal Bus/ModBus
- X16 = 24V
- X17 = eBus
- X18 = 24V (max 5VA)
- X19 = Signal output

### Plus pcb

- X03 = 24V
- X04 = internal Bus
- X06 = ModBus
- X08 = Contact input 1
- X09 = Contact input 2
- X10 = Relais output 1
- X11 = Relais output 2
- X12 = Analog input (0 to 10 V)
- X13 = Analog input (0 to 10 V)
- X14 = Analog output (0 or 10 V)
- X15 = Analog output 2 (0 or 10 V)
- X16 = NTC 10K
- X17 = LAN

### Wire colours

- |                   |              |
|-------------------|--------------|
| C1 = brown        | C8 = grey    |
| C2 = blue         | C10 = yellow |
| C3 = green/yellow | C11 = green  |
| C5 = white        | C17 = purple |



### Important !

When installing and maintaining the appliance (see → Maintenance installer page 32 ), check that no dust or dirt has accumulated on the preheater! Clean these well during maintenance.

# 11 Electrical connections accessories

## 11.1 Connecting multiple switch

A multiple switch must be connected to the modular connector type X14 on the basic PCB. This modular connector X14 is accessible from the rear of the control. With an appliance with Plus pcb the cover first has to be removed in order to gain access to this modular connector (→ Optional Plus pcb page 13). Depending on the type of multiple switch that is connected, one can use either an RJ11 or RJ12 plug.

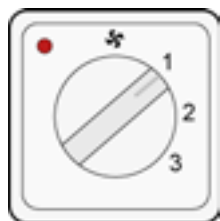

It is best to use a 4-way switch with filter indication; always install an RJ12 connector in combination with a 6-core modular cable.

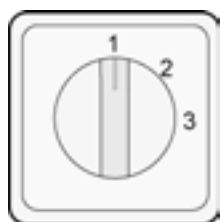

When using a 3-way switch without filter indication always install an RJ11 connector in combination with a 4-core modular cable.

### 11.1.1 Connecting multiple switch with filter indication

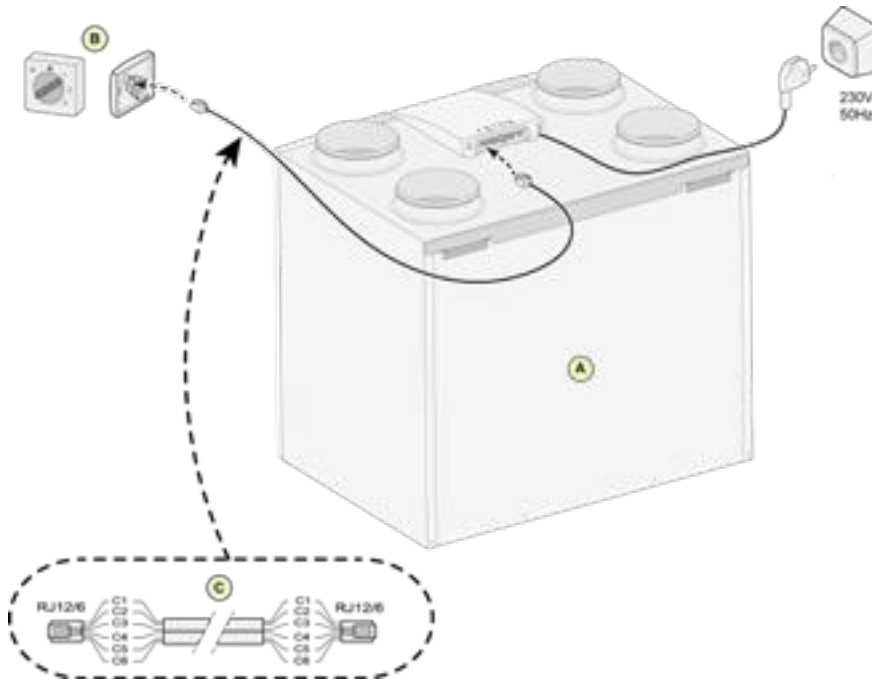

A = Ubiflux Vigor appliance (For example a Ubiflux Vigor appliance type 4-0)

B = 4-way switch with filter indication

C = Modular cable: Note: For the modular cable that is used, the "tab" of both modular connectors must be mounted facing the mark on the modular cable. Wire colors C1 - C6 may vary dependent on the type of modular cable used.

### 11.1.2 Connecting wireless remote control (without filter indication)

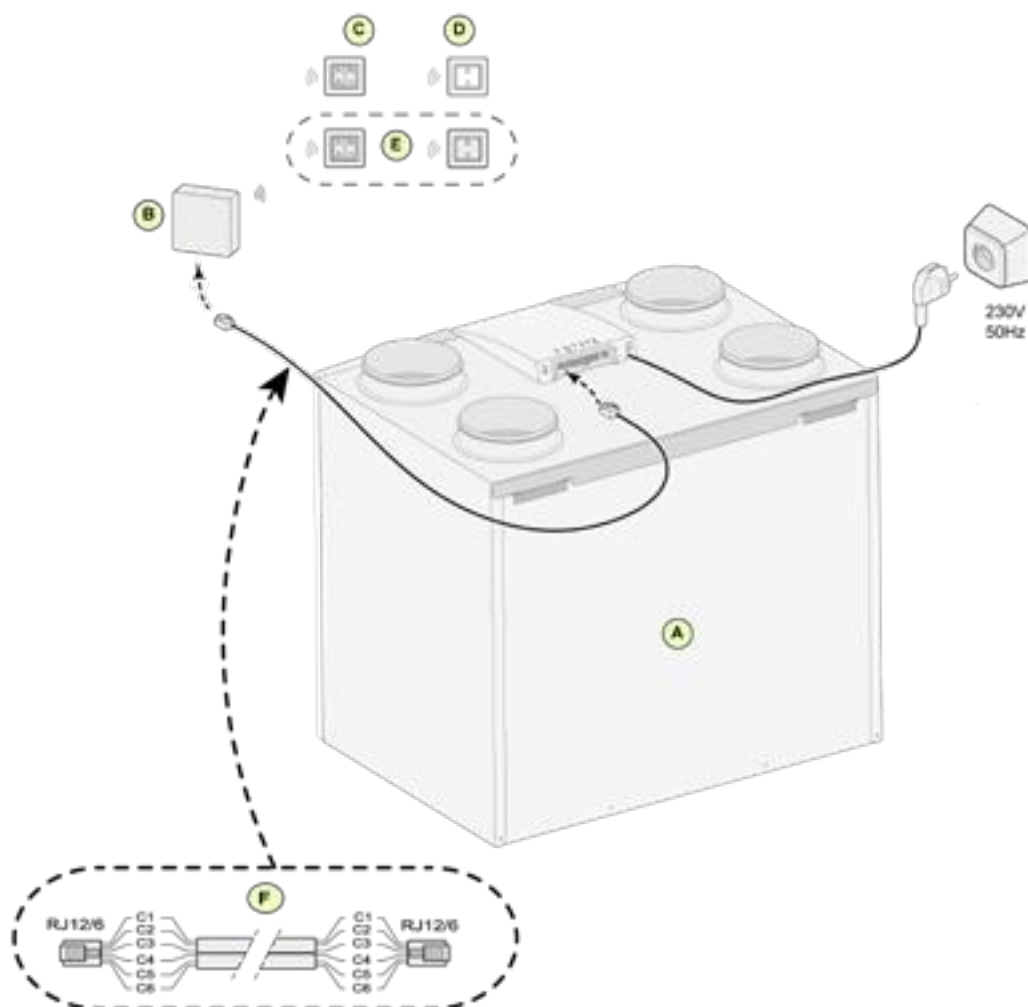

A = Ubiflux Vigor appliance (For example a Ubiflux Vigor appliance type 4-0)

B = Receiver for wireless remote control

C = Transmitter with 4 settings (for example kitchen)

D = Transmitter with 2 settings (for example bathroom)

E = Any additional 2- or 4-settings transmitters (maximum of 6 transmitters can be signed on to 1 receiver)

F = Modular cable: Note: For the modular cable that is used, the "tab" of both modular connectors must be mounted facing the mark on the modular cable. Wire colors C1 - C6 may vary dependent on the type of modular cable used.

### 11.1.3 Connecting extra multiple switch with filter indication

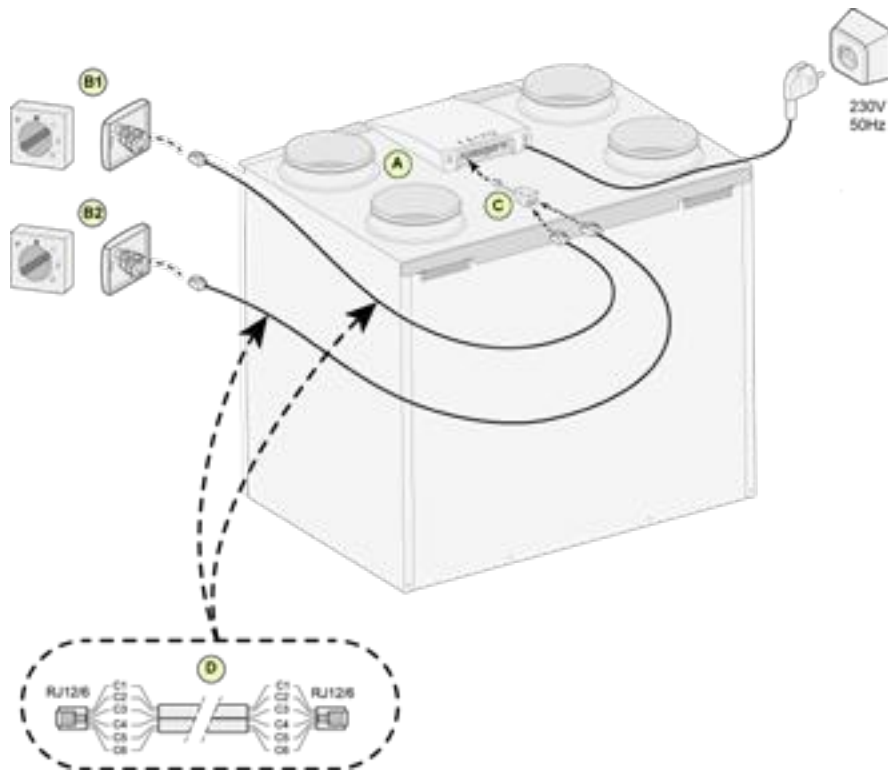

A = Ubiflux Vigor appliance (For example a Ubiflux Vigor appliance type 4-0)

B1 = Multiple switch with filter indication

B2 = Extra multi switch with filter indication

C = Splitter

D = Modular cable: Note: For the modular cable that is used, the "tab" of both modular connectors must be mounted facing the mark on the modular cable. Wire colors C1 - C6 may vary dependent on the type of modular cable used.

### 11.1.4 Connecting extra multiple switch with filter indication

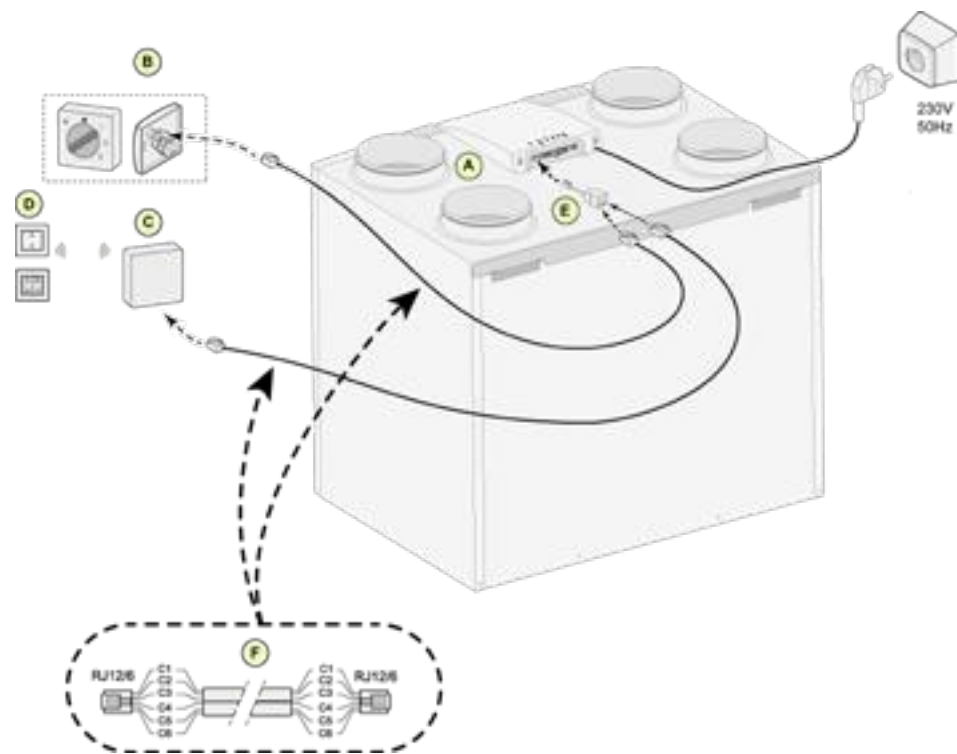

A = A = Ubiflux Vigor appliance (For example a Ubiflux Vigor appliance type 4-0)

B = Multiple switch with filter indication

C = Receiver for wireless remote control

D = Transmitter with 2 settings or 4 settings

E = Splitter

F = Modular cable: **Note:** For the modular cable that is used, the "tab" of both modular connectors must be mounted facing the mark on the modular cable. Wire colors C1 - C6 may vary dependent on the type of modular cable used.

## 11.2 Connecting Air Control

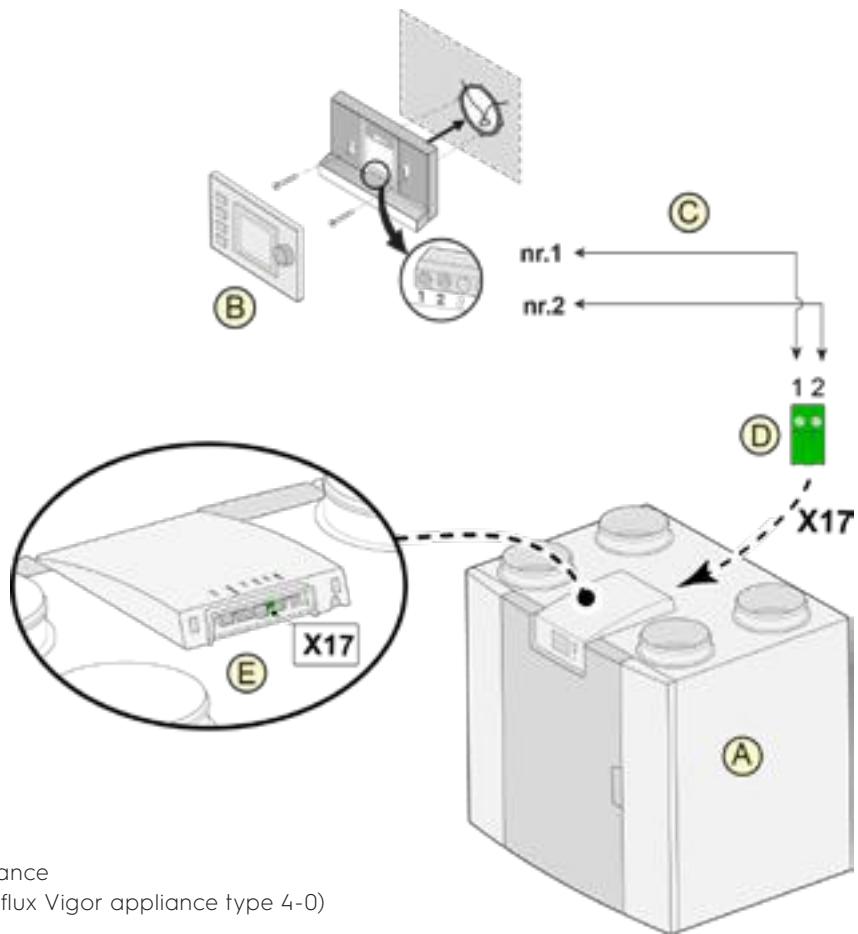

A = Ubiflux Vigor appliance  
(For example a Ubiflux Vigor appliance type 4-0)

B = Air Control (option)

C = Two-core control cables

D = Green two-pole screw connector

E = Position green eBus connector to rear of control

## 11.3 Connecting humidity sensor

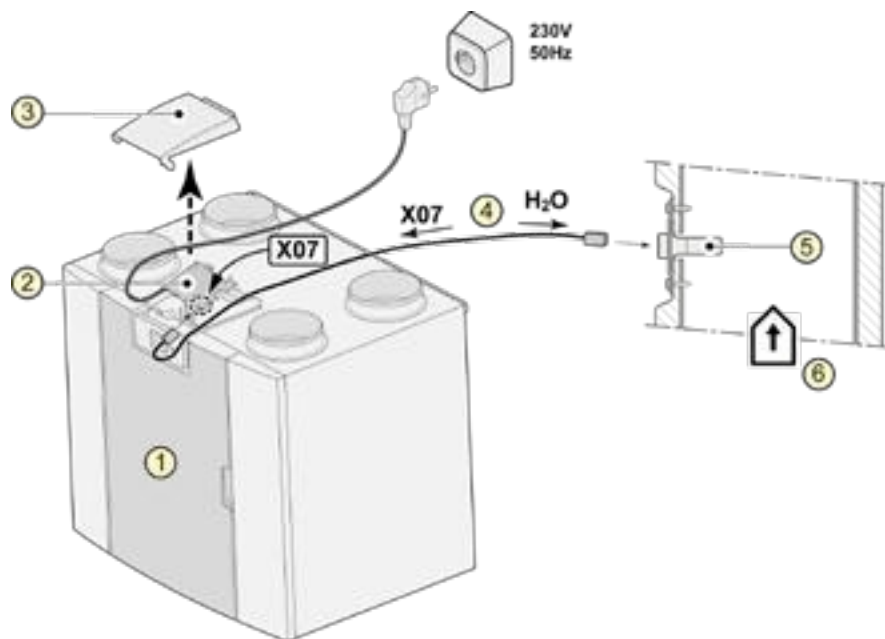

1 = Ubiflux Vigor appliance (For example a Ubiflux Vigor appliance type 4-0)

2 = Basis pcb

3 = Cover

4 = The cable that comes with RH cable

5 = RH (humidity) sensor

6 = Duct from dwelling

To switch on and set the sensitivity of the humidity sensor, go to step number 7.1 and 7.2 in the settings menu .

## 11.4 Connecting CO<sub>2</sub> sensor(s)

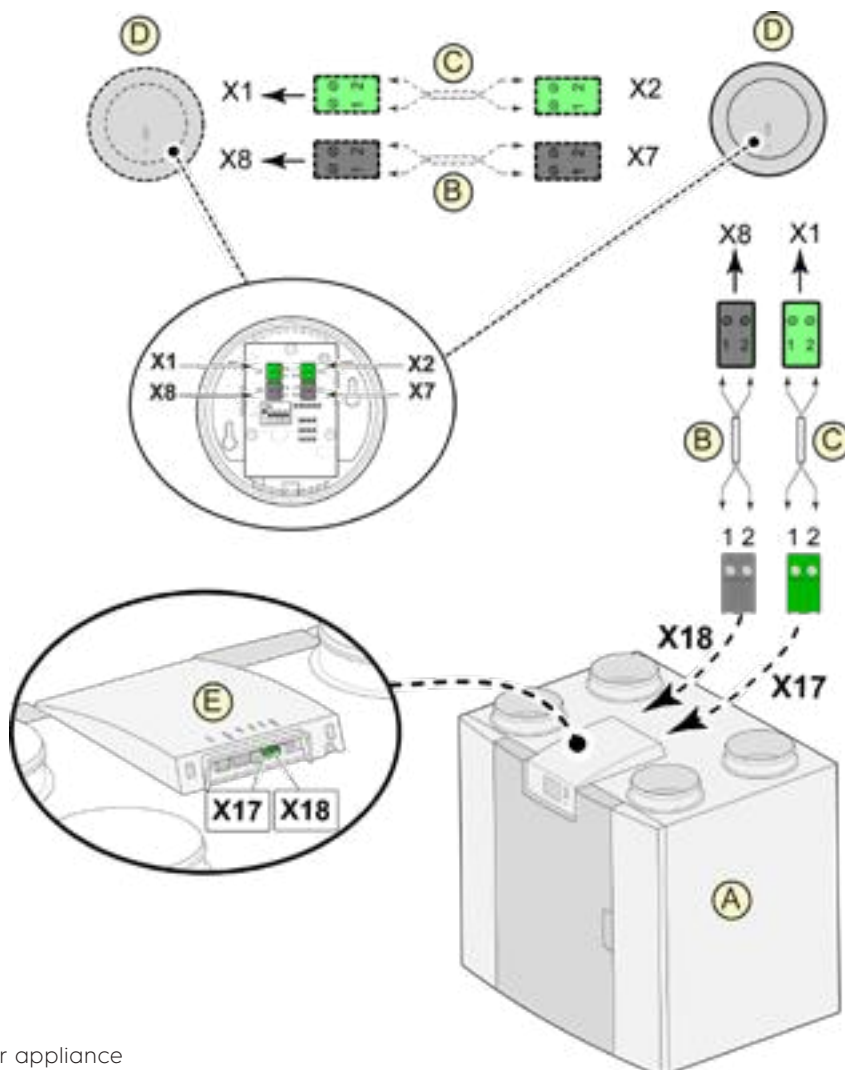

A = Ubiflux Vigor appliance  
(For example a Ubiflux Vigor appliance type 4-0)

B = 2-pole control cable for 24V power supply (black connectors)

C = 2-core control cable for eBus connection (green connectors)

D = CO<sub>2</sub> sensor(s); connect a maximum of 4

E = Connection X17 (eBus) and X18 (24V) on Ubiflux Vigor appliance

For switching the CO<sub>2</sub> sensor(s) on and off, select the right setting at step number 6.1 in the settings menu ; in order to set the minimum and maximum PPM value of the CO<sub>2</sub> sensor(s) set, if necessary, the right values following step numbers 6.2 to 6.9.

## 11.5 Connecting postheater

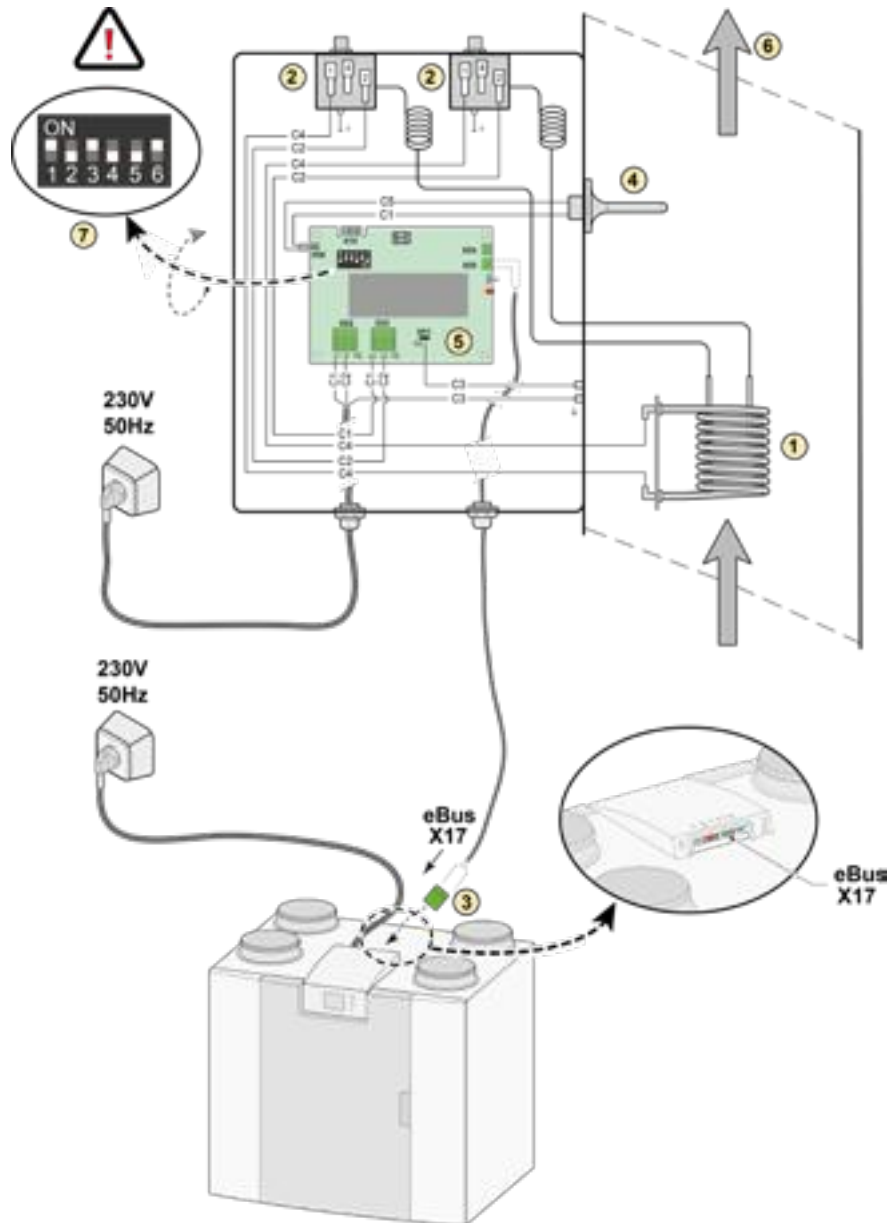

1. Heating coil
2. Maximum safety with manual reset
3. 2-pole eBus connection X17 on Ubiflux Vigor appliance
4. Temperature sensor
5. PCB type UVPI
6. Airflow direction
7. Dipswitch setting Ubiflux Vigor postheater

- C1 = brown  
 C2 = blue  
 C3 = green/yellow  
 C4 = black  
 C5 = white

## 11.6 Connecting preheater

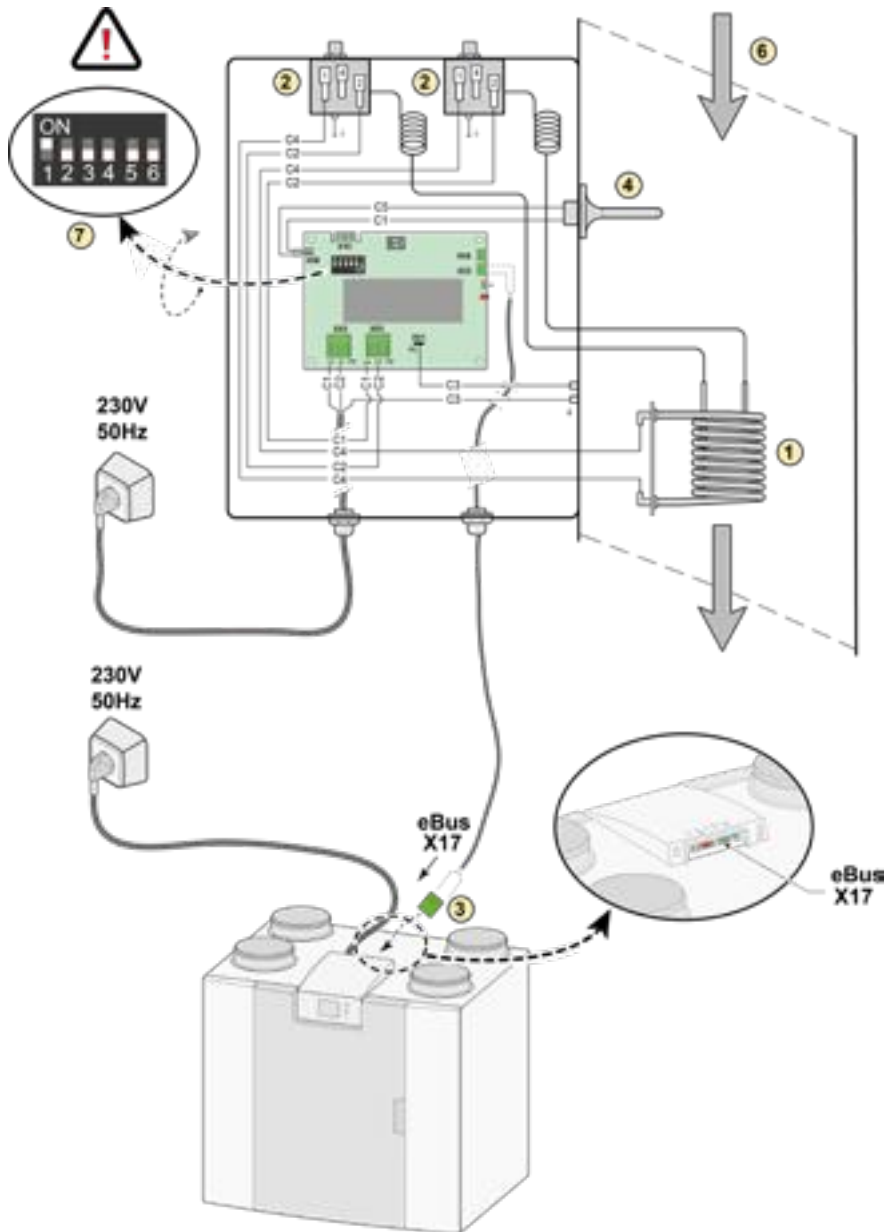

1. Heating coil
2. Maximum safety with manual reset
3. 2-pole eBus connection X17 on Ubiflux Vigor appliance
4. Temperature sensor
5. PCB type UVPI
6. Airflow direction
7. Dipswitch setting Ubiflux Vigor postheater

- C1 = brown
- C2 = blue
- C3 = green/yellow
- C4 = black
- C5 = white

## 11.7 Connecting Geo-heat exchanger

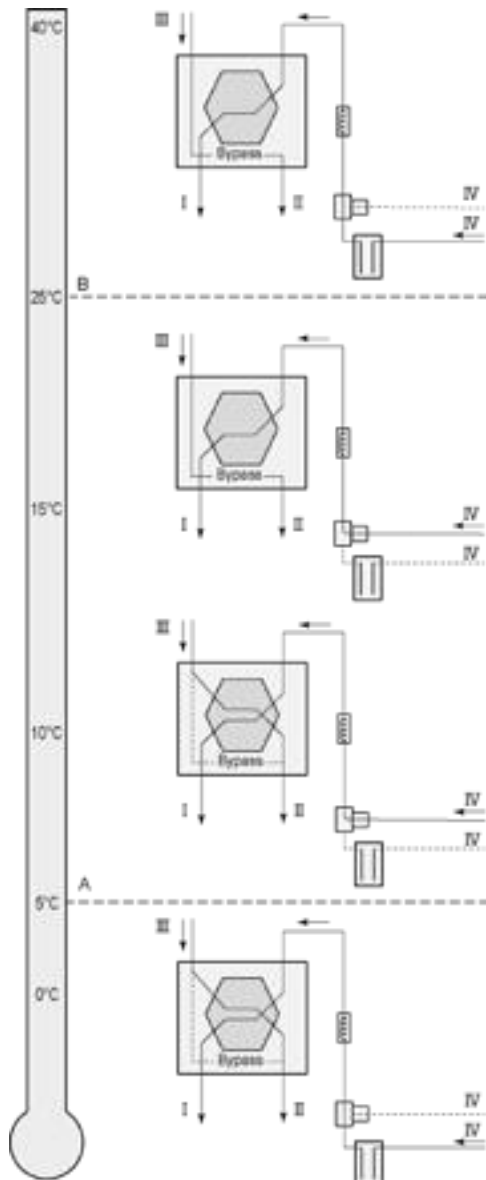

A geo heat exchanger can be connected to the Ubiflux Vigor appliance with Plus PCB.

Depending on the type of valve the geo heat exchanger can be connected to different connection of the Plus PCB:

X10 no. 1 & 2 - Relay output 1 (Factory setting)

X11 no. 1 & 2 - Relay output 2

X14 no. 1 & 2 - Analogue output 1 (0 - 10 V)

X15 no. 1 & 2 - Analogue output 2 (0 - 10 V)

Connect the outdoor temperature sensor to no. 1 and no. 2 of the 2-pole connector X-16.

A = Min. temperature

B = Max. temperature

I = To dwelling

II = To outside

III = From dwelling

IV = From outside

When using a geo heat exchanger, parameter 11.1 must be changed from "OFF" to "ON".

Step No.	Description	Factory setting	Range
11.1	Switching on and off Off On/ off	off	On/ off
11.2	Switch temperature 1	5°C	0.0 °C / 10.0 °C
11.3	Switch temperature 2	25°C	15.0°C / 40.0 °C
11.4	Mode valve 10 volt control	Closed	Open / Closed
11.5	Valve control	Relay output 1	Relay output 1/Relay output 2/ Analogue output 1/Analogue output 2

# 12 Service

## 12.1 Exploded view

When ordering parts, in addition to the article code number (see exploded view), please state the heat recovery appliance type, the serial number, the year of production and the name of the part:

**N.B. :**

Appliance type, serial number and year of production are stated on the identification plate behind the plastic front panel on the appliance.

Exemple	
Type d'appareil	Ubiflux Vigor W600
Appliance type	432000221201
Year of production	2022
Part	Fan
Article code	533037
Quantity	1

## 12.2 Service articles

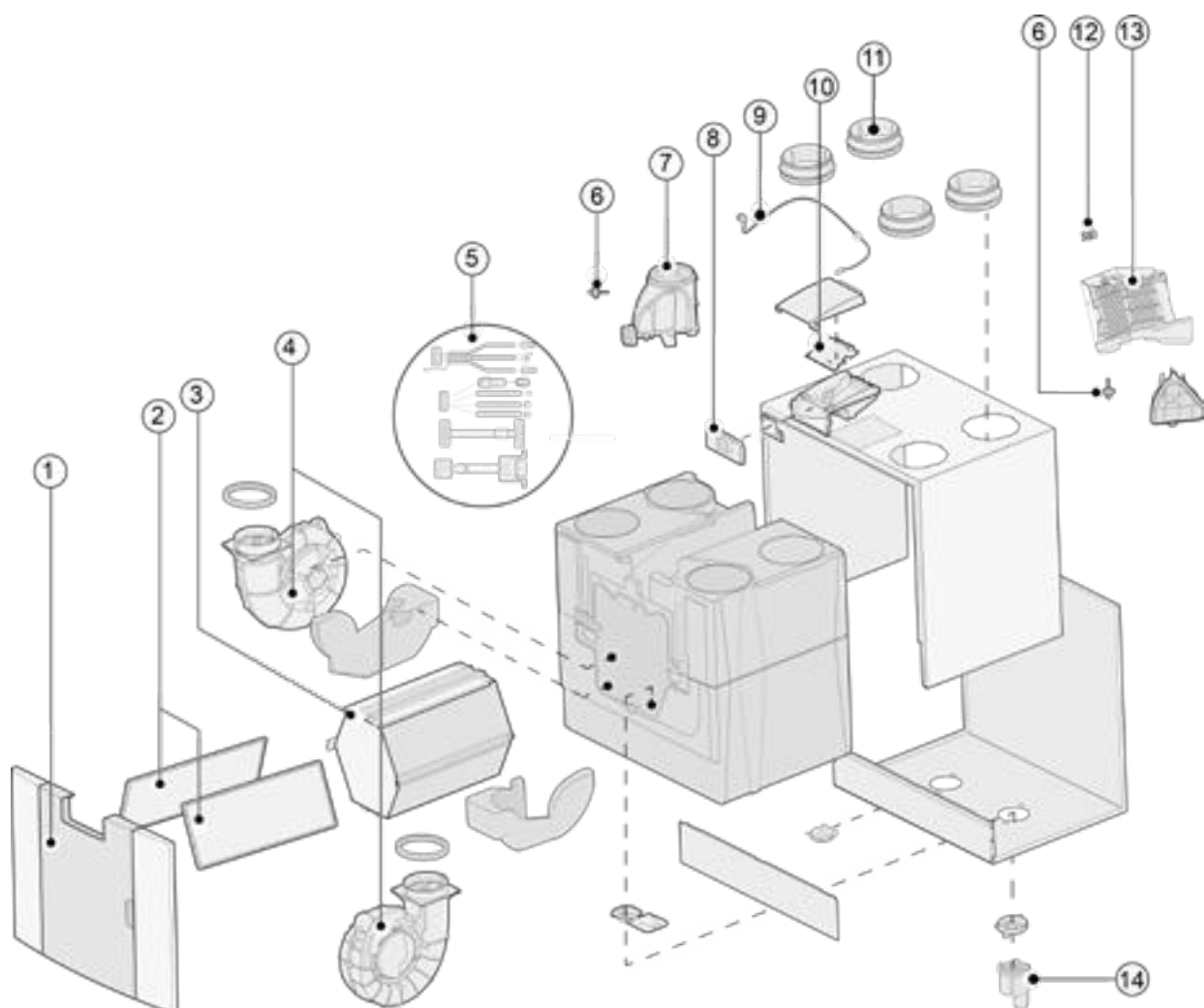

No.	Article description	Article code
1	Front panel complete Ubiflux Vigor W600	0883270
2	Filters (2 items) ISO Coarse 60%	0886010
3	Heat exchanger	0886017
4	Fan (1 item)	0886018
5	Cable set	0883265
6	Temperature sensor NTC 10K (1 item)	0704637
7	Bypass valve with motor complete	0886019
8	Display pcb UBP-2	0883258
9	Mains plug and cable 230 V *	0883261
10	Basic pcb UWA2-B	0883244
11	Collars 200 mm	0886078
12	Maximum security	0886020
13	Internal preheater	0883264
14	Condensation discharge	0883246

\* The power cable is fitted with a circuit board connector. When replacing it, always order a replacement mains cable from Ubbink

**To prevent dangerous situations, a damaged mains connection can only be replaced by a qualified expert.**

# 13 Setting values

## 13.1 Setting values standard appliance

The below setting values are for a Ubiflux Vigor W600 **without** Plus pcb.

Step No	Description	Factory settings	Setting range	Comment
<b>1 Flow rate</b>				
1.1	Air flow rate setting 0	100 m <sup>3</sup> /u	0 or adjustable between 100 m <sup>3</sup> /h and 600 m <sup>3</sup> /h (never higher than step no. 1.2)	
1.2	Air flow rate setting 1	150 m <sup>3</sup> /u	Adjustable between 100 m <sup>3</sup> /h and 600 m <sup>3</sup> /h (not higher than step no. 1.3 or lower than step no. 1.1)	
1.3	Air flow rate setting 2	300 m <sup>3</sup> /h	Adjustable between 100 m <sup>3</sup> /h and 600 m <sup>3</sup> /h (not higher than step no. 1.4 or lower than step no. 1.2)	
1.4	Air flow rate setting 3	500 m <sup>3</sup> /h	Adjustable between 100 m <sup>3</sup> /h and 600 m <sup>3</sup> /h (not lower than step no. 1.3)	
1.5	Imbalance permissible	Yes	Yes/No	
1.6	Imbalance (Open fireplace)	0%	0% - +20%	
1.7	Offset supply	0%	-15% / +15% fan setting	Value calculated back to set flow rate, see screen
1.8	Offset exhaust	0%	-15% / +15% fan setting	
1.19	Default fan setting	1	0 or 1	
<b>2 Bypass</b>				
2.1	Mode Bypass	Automatic	- Automatic - Bypass closed - Bypass open	
2.2	Bypass temperature "from dwelling"	24 °C	15 °C / 35 °C	
2.3	Bypass temperature "from outside"	10 °C	7 °C / 15 °C	
2.4	Bypass hysteresis	2 °C	0 °C / 5 °C	
2.5	Mode Bypass boost	Off	On / Off	
2.6	Fan setting selection Bypass boost	3	0 / 3	
<b>3 Frost protection</b>				
3.1	Frost temperature	0 °C	-1,5 °C / 1,5 °C	
3.2	Minimum intake temperature	10 °C	7°C / 22 °C	

Step No	Description	Factory settings	Setting range	Comment
<b>4</b>	<b>Filter message</b>			
4.1	Number of days until filter message	90	1 / 365 days	
4.2	Start of filter wizard	No	Yes/No	
4.3	Filter reset	No	Yes/No	
<b>5</b>	<b>External heater</b>			
5.1	Preheater on and off	Off	On/Off	
5.2	Postheater on and off	Off	On/Off	
5.3	Temperature postheater	21 °C	15 °C / 30 °C	
<b>6</b>	<b>CO2 sensor</b>			
6.1	Switching eBus CO2 sensor off and on	Off	On/ Off	
6.2	Min. PPM eBus CO2 sensor 1	400 PPM	400 - 2000 PPM	
6.3	Max. PPM eBus CO2 sensor 1	1200 PPM		
6.4	Min. PPM eBus CO2 sensor 2	400 PPM		
6.5	Max. PPM eBus CO2 sensor 2	1200 PPM		
6.6	Min. PPM eBus CO2 sensor 3	400 PPM		
6.7	Max. PPM eBus CO2 sensor 3	1200 PPM		
6.8	Min. PPM eBus CO2 sensor 4	400 PPM		
6.9	Max. PPM eBus CO2 sensor 4	1200 PPM		
<b>7</b>	<b>Humidity sensor</b>			
7.1	Switching humidity sensor on and off	Off	On / Off	
7.2	Sensitivity of humidity sensor	0	+2 = most sensitive 0 = basic setting -2 = least sensitive	
<b>8</b>	<b>Cascade</b>			
8.1	Appliance setting	0 (Master)	0 / 9 (0=Master; 1 t/m 9 = Slave 1 t/m Slave 9)	
<b>12</b>	<b>Central heating + heat recovery</b>			
12.1	Status	Off	On/Off	

Step No	Description	Factory settings	Setting range	Comment
<b>14</b>	<b>Communication</b>			
14.1	Type of Bus connection	ModBus	Off / ModBus/ internal Bus	
14.2	Slave address	20	1 - 247	For Modbus
14.3	Baudrate	19k2	1200 / 2400 / 4800/ 9600/ 19k2 / 38k4 / 56k / 115k2	For Modbus
14.4	Parity	Even	No / Even / Odd	For Modbus
<b>15</b>	<b>Appliance settings</b>			
15.1	Language	English	English/ German/ French/ Dutch/Lithuanian/ Danish/ Italian/ Polish/Spanish/ Romanian/ Slovak/ Slovenian/ Estonian/ Norwegian/ Czech/ Hungarian/Latvian	
15.2	Date format	dd-mm-yyyy	dd-mm-yyyy / mm-dd-yyyy	
15.3	Date			
15.4	Time format	24u	12h / 24h	
15.5	Time			
15.8	Display	No	Yes / No	Display half an hour active as multiple switch; when "yes" is selected touchscreen permanently set as multiple switch
15.9	Back to factory settings	No	Yes / No	
15.10	Fan position wizard	No	Yes / No	
<b>16</b>	<b>Signal output</b>			
16.1	Signal output	off	Off / Only filter condition / Only fault condition / Filter and fault condition	Connector X19
<b>17</b>	<b>Standby</b>			
17.1	Switch off appliance	No	Yes / No	

## 13.2 Setting values appliance with Plus pcb

The below setting values are for a Ubiflux Vigor W600 **with** Plus pcb.

Step No	Description	Factory settings	Setting range	Comment
<b>9</b>	<b>Switch contacts</b>			
9.1	Make or break contact 1	Make	Make / Break	
9.2	Switch contact control 1	off	Off On Meets Bypass conditions Open bypass valve Open external valve	
9.3	Contact 1 Supply fan action	Fan off	Fan off Fan runs at absolute minimum Fan at setting 1 Fan at setting 2 Fan at setting 3 Fan at step 0 Fan according to multiple switch Fan runs at absolute maximum No supply fan control	
9.4	Contact 1 Exhaust fan action	Fan off	Fan off Fan runs at absolute minimum Fan at setting 1 Fan at setting 2 Fan at setting 3 Fan at step 0 Fan according to multiple switch Fan runs at absolute maximum No exhaust fan control	
9.5	Make or break contact 2	Make	Make / Break	
9.6	Switch contact control 2	Off	Off On Meets Bypass conditions Open bypass valve Open external valve	
9.7	Contact 2 Supply fan action	Fan off	Fan off Fan runs at absolute minimum Fan at setting 1 Fan at setting 2 Fan at setting 3 Fan at step 0 Fan according to multiple switch Fan runs at absolute maximum No supply fan control	
9.8	Contact 2 Exhaust fan action	Fan off	Fan off Fan runs at absolute minimum Fan at setting 1 Fan at setting 2 Fan at setting 3 Fan at step 0 Fan according to multiple switch Fan runs at absolute maximum No exhaust fan control	

Step No	Description	Factory settings	Setting range	Comment
<b>10</b>	<b>0 - 10 V.</b>			
10.1	Mode input 1	Off	On / Off	
10.2	minimum voltage input 1	0V	0V - 10V	Connecteur X-12
10.3	maximum voltage input 1	10V	0V - 10V	
10.4	Mode input 2	Off	On / Off	
10.5	minimum voltage input 2	0V	0V - 10V	Connecteur X-13
10.6	maximum voltage input 2	10V	0V - 10V	
<b>11</b>	<b>Geo-heat exchanger</b>			
11.1	Switching on and off	Off	On / Off	
11.2	Switch temperature 1	5 °C	0,0 °C / 10,0 °C	
11.3	Switch temperature 2	25 °C	15,0 °C / 40,0 °C	
11.4	Mode valve 24 volt control	Closed	Open / Closed	
11.5	Valve control	Relay output 1	Relay output 1/ Relay output 2/ Analogue output 1/ Analogue output 2	

# 14 Conformity declaration

## Déclaration de conformité

**Fabricant :** Ubbink NV

**Adresse :** Jan Samijnstraat 9  
BE-9050, Gentbrugge, Belgium

**Produit :** Heat recovery appliance type:  
Ubiflux Vigor W600

The product described above complies with the following directives:

- 2014/35/EU (OJEU L 96/357; 29-03-2014)
- 2014/30/EU (OJEU L 96/79; 29-03-2014)
- 2009/125/EU (OJEU L 285/10; 31-10-2009)
- 2017/1369/EU (OJEU L 198/1; 28-07-2017)
- RoHS 2011/65/EU (OJEU L 174/88; 01-07-2011)

The product described above has been tested according to the following standards:

- EN 55014-1: 2017 + A11: 2020
- EN 55014-2: 2021
- EN IEC 61000-3-2: 2019 + A1:2021
- EN 61000-3-3: 2013 + A1:2019
- EC 61000-3-3: 2013/AMD2:2021
- EN 60335-1: 2012 + AC:2014 + A11:2014 + A13:2017 + A1:2019 + A2:2019 + A14:2019
- EN 60335-2-40: 2003 + A11 + A12 + A1 + C + A13 + AC:2013
- EN 62233: 2008 + AC:2008

Gentbrugge, 01-06-2022  
B. Vanlede  
Managing Director



# 15 ERP values

Technical information sheet Ubiflux Vigor W600 in accordance with Ecodesign (ErP), no. 1254/2014 (Annex IV)					
Manufacturer:		Ubbink NV			
Model:		Ubiflux Vigor W600 (Plus)			
Climate zone	Type of control	SEC Value in kWh/m <sup>2</sup> /a	SEC Class	Annual electricity consumption (AEC) in kWh	Annual heating saved (AHS) in kWh
Average	manual	-38,02	A	358	4630
	clock control	-38,92	A	328	4643
	1x sensor (RV/CO <sub>2</sub> /VOC)	-40,60	A+	271	4670
	2 or more sensors (RV/CO <sub>2</sub> /VOC)	-43,49	A+	177	4724
Cold	manual	-76,92	A+	895	9057
	clock control	-77,95	A+	865	9083
	1x sensor (RV/CO <sub>2</sub> /VOC)	-79,89	A+	808	9136
	2 or more sensors (RV/CO <sub>2</sub> /VOC)	-83,29	A+	714	9242
Hot	manual	-13,93	E	313	2093
	clock control	-13,93	E	283	2100
	1x sensor (RV/CO <sub>2</sub> /VOC)	-15,46	E	226	2112
	2 of meerdere sensoren (RV/CO <sub>2</sub> /VOC)	-18,06	E	132	2136
Type of ventilation unit:		Balanced residential ventilation appliance with heat recovery			
Fan:		EC - fan with infinitely variable control			
Type of heat exchanger:		Recuperative plastic cross-counterflow heat exchanger			
Thermal efficiency		92 %			
Maximum flow rate:		600 m <sup>3</sup> /h			
Maximum rated power:		282 W			
Sound power level Lwa:		53 dB(A)			
Reference flow rate:		420 m <sup>3</sup> /h			
Reference pressure:		50 Pa			
Specific Power Input (SEL):		0,20 Wh/m <sup>3</sup>			
Control factor:		1.0 in combination with multiple switch			
		0.95 in combination with clock control			
		0.85 in combination with 1 sensor			
		0.65 in combination with 2 or more sensors			
Leakage*	Internal	0,70 %			
	External	0,70 %			
Position dirty filter indication:		On the display of the appliance / on the multiple switch (LED) / on the Air Control. <b>Attention!</b> For optimal energy efficiency and a proper operation, a regular filter inspection, cleaning or replacement is necessary.			
Internet address for Assembly instructions:		<a href="http://www.ubbink.be">http://www.ubbink.be</a>			
Bypass :		Yes, 100% Bypass			

\*Measurements executed by TZWL according to the DiBi-standards

Classification from 1 January 2016	
SEC class ("Average climate zone")	SEC in kWh/m <sup>2</sup> /a
A+ (le plus efficace)	SEC < -42
A	-42 ≤ Pa < -34
B	-34 ≤ Pa < -26
C	-26 ≤ Pa < -23
D	-23 ≤ Pa < -20
E (Least efficient)	-20 ≤ Pa < -10

# 16 Recycling

Sustainable materials are used in the manufacture of this appliance. The packaging should be disposed of in a responsible manner and in accordance with governmental regulations.







Ubbink NV/SA - Jan Samijnstraat 9, B - 9050 Gentbrugge  
Tel. +32 (0)9 237 11 00 - [www.ubbink.be](http://www.ubbink.be) - [info@ubbink.be](mailto:info@ubbink.be)

Ubbink (UK) Ltd. - Unit 2, Redbourne Park, Liliput Road  
Brackmills Ind. Est., Northampton, NN4 7DT - T +44 (0)1604 433000, F. +44 (0)1604 433001